

2022

LEAD-ACID BATTERIES



DELTA lead-acid rechargeable batteries

DELTA is brand of reliable lead-acid VRLA batteries (Valve Regulated Lead Acid), presented on the market since 2001. DELTA is widely used in telecommunications, security systems, access control, power supply systems for mobile operators' base stations, solar and wind power systems, uninterruptible power supplies, and even motor vehicles.

DELTA batteries are manufactured using AGM and GEL technology and meet all modern requirements of autonomous, uninterruptible and backup power supply systems.

The DELTA product range includes several series optimized for use in various industries and systems.

FOR LOW CURRENT SYSTEMS	5 years	DT pages 2-5
	5 years	DTS pages 6-9
UNIVERSAL BATTERIES	6 years	DTM pages 10-13
	10-12 years	DTM L pages 14-17
UPS SERIES	8 years	HR pages 18-21
	8 years	HR-W pages 22-25
	12 years	HRL-X pages 26-29
SOLAR SERIES	10 years	DTX pages 30-33
	10-12 years	GEL pages 34-37
	15 years	GX pages 38-41
	15 years	CGD pages 42-45
SPECIAL PURPOSE	10 years	FT-M pages 46-49
STARTER BATTERIES		CT pages 50-51
		EPS pages 52-53

DT FOR LOW CURRENT SYSTEMS

DELTA lead-acid batteries of DT series are specially designed for use in low current systems and optimized for buffer operation. They are manufactured using AGM technology (Absorbent Glass Mat - an electrolyte absorbed in a fiberglass separator). DELTA DT series batteries have low internal resistance and high energy density. They meet international safety standards and are recommended for use in fire protection systems and access control and management systems.

Scopes of application:

- Safety systems
- Electronic cash registers
- Electronic test equipment
- Emergency lighting systems
- Geophysical and geodetic equipment
- Control and access systems

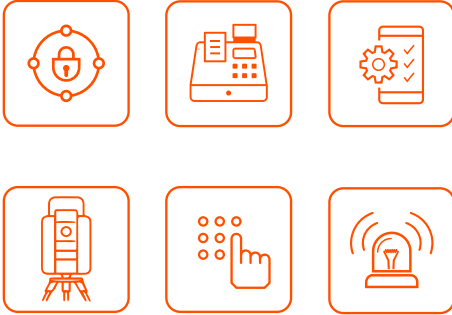

Service life	In buffer mode	up to 40Ah – 5 years, over 65Ah – 7-10 years
	In cyclic mode	up to 40Ah – 1000 cycles at 30% discharge depth, over 65Ah – 1100 cycles at 30% discharge depth.
Self-discharge		Less than 3% per month
Charging method	DC voltage charging	25°C
	Cyclic mode	2,4-2,5 V/cell Temperature compensation - 5 mV/cell°C
	Buffer mode	2,27-2,3 V/cell Temperature compensation - 3.3 mV/cell°C

Terminal diagrams

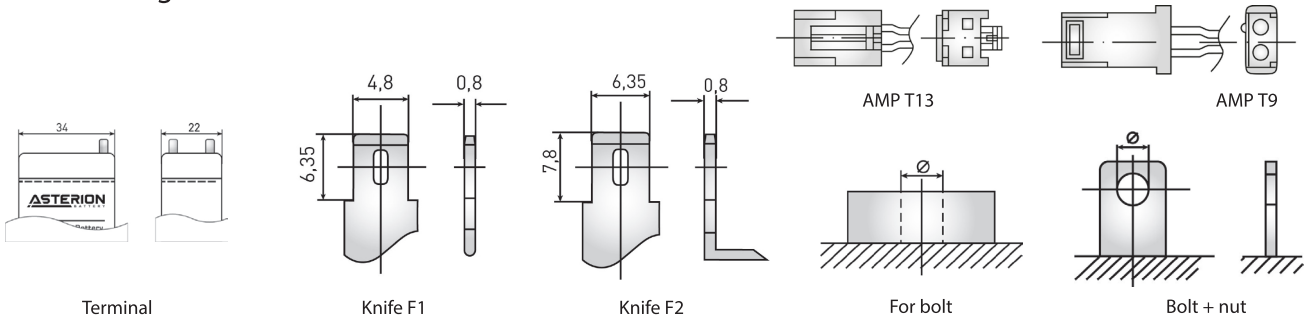

Battery construction

Component	Positive plate	Negative plate	Container	Cover	Valve	Terminals	Separator	Electrolyte
Material	Lead dioxide	Lead	ABS	ABS	Rubber	Copper	Fiberglass	Sulfuric acid

Housing types

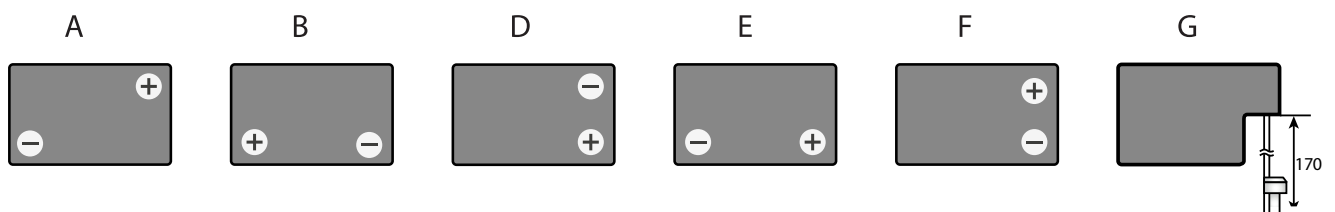

TEMPERATURE INFLUENCE ON THE CAPACITANCE

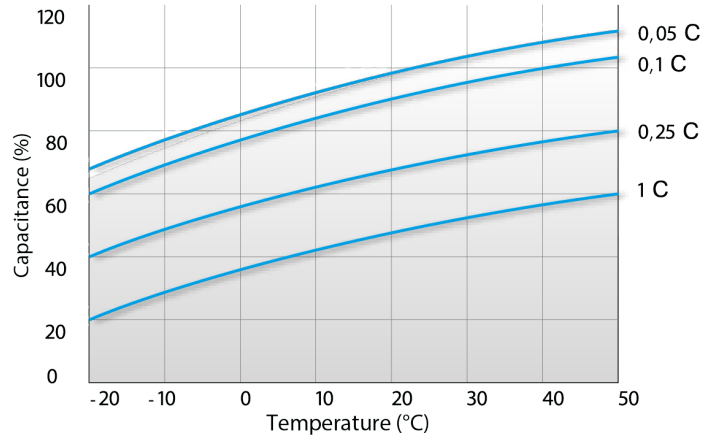

SERVICE LIFE IN CYCLIC MODE

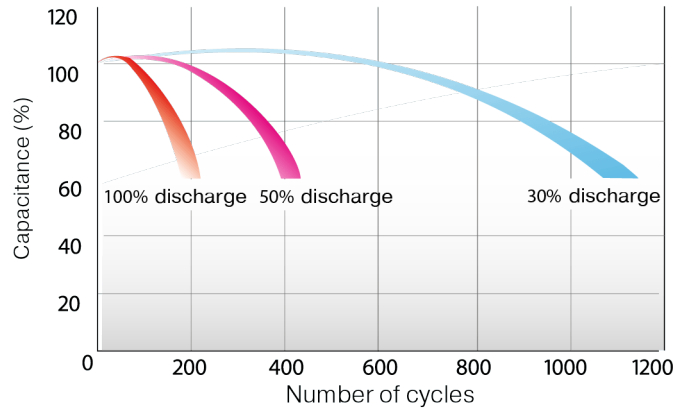

SERVICE LIFE IN BUFFER MODE (5 YEARS)

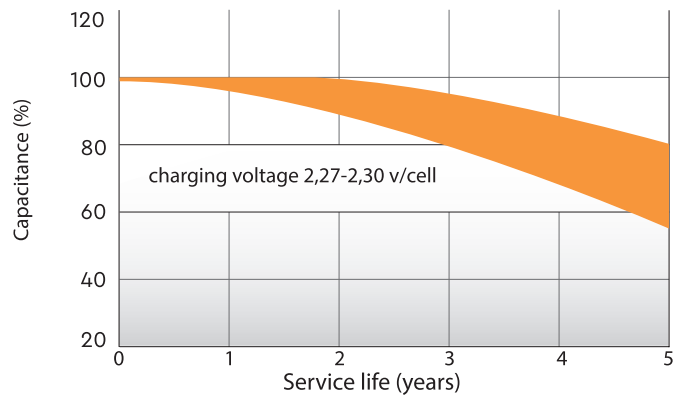

DISCHARGE CHARACTERISTICS

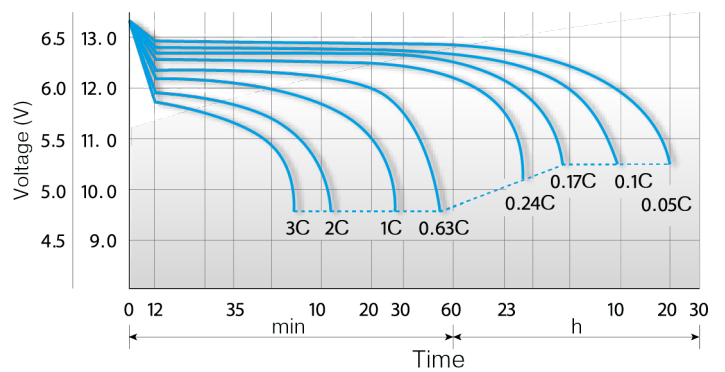

SERVICE LIFE IN CYCLIC MODE (Over 40 Ah)

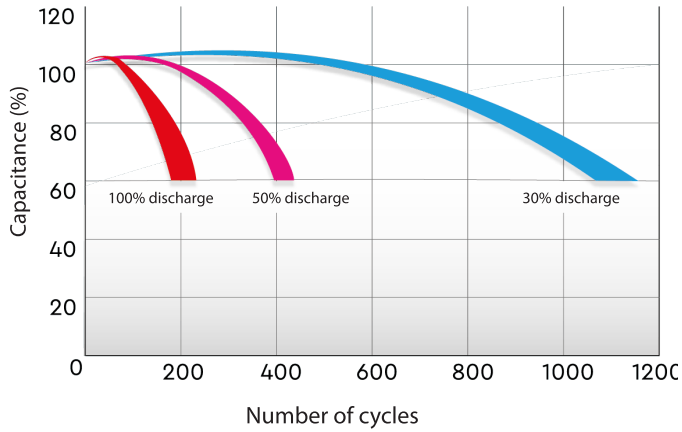

SERVICE LIFE IN BUFFER MODE (5 YEARS)

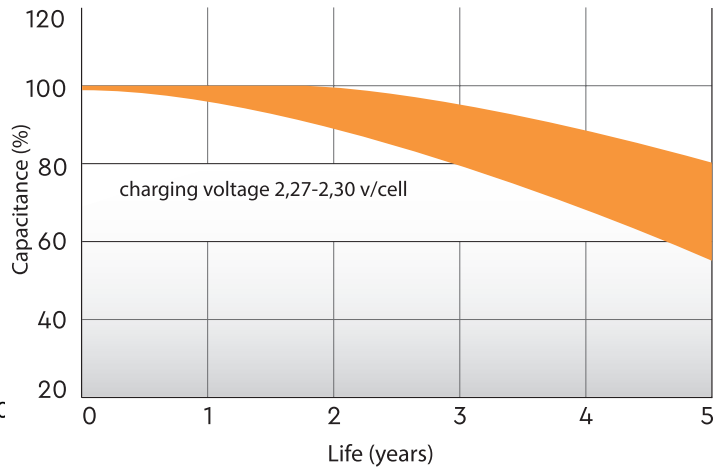

Standard sizes

Type (Old)	Voltage, V	Capacitance, Ah*	Length (±2), mm	Width (±2), mm	Height max (±2), mm	Weight, kg	Body	Terminal type
DT 401	4	1	35	22	69	0.1	D	Terminal
DT 4003	4	0.3	26	21	40	0,045	F	Terminal
DT 4035	4	3.5	90	34	66	0.46	B	Knife F1
DT 4045	4	4.5	70	47	105	0.5	A	Knife F1
DT 6012	6	1.2	97	24	58	0.29	B	Knife F1
DT 6015	6	1.5	97	24	58	0.3	B	Knife F1
DT 6023	6	2.3	44	47	107	0.45	A	Knife F1
DT 6028	6	2.8	66	33	99	0.61	A	Knife F1
DT 6033	6	3.3	134	34	66	0.65	B	Knife F1
DT 6033 (125)	6	3.3	125	33	67	0.64	B	Knife F1
DT 6045	6	4.5	70	47	107	0.75	A	Knife F1
DT 606	6	6	70	47	107	0.81	A	Knife F1
DT 612	6	12	151	50	100	1.6	B	Knife F2
DT 12008	12	0.8	97	25	63	0.4	G	AMP
DT 12012	12	1.2	97	43	59	0.55	F	Knife F1
DT 12022	12	2.2	178	35	66	0.94	B	Knife F1
DT 12032	12	3.3	135	67	67	1.35	D	Knife F1
DT 12045	12	4.5	90	70	107	1.55	B	Knife F1
DT 1207	12	7	151	65	102	2.05	D	Knife F1
DT 1212	12	12	151	98	101	3.6	D	Knife F2
DT 1218	12	18	181	76	168	5.2	E	Bolt + nut Ø 4-5.5 mm
DT 1226	12	26	167	175	126	8.0	E	For M5 bolt
DT 1233	12	33	197	131	180	10.1	B	Bolt + nut Ø 6-8 mm
DT 1240	12	40	198	166	170	12.9	E	For M6 bolt
DT 1265	12	65	350	167	179	20.5	B	For M6 bolt
DT 1275	12	75	259	169	213	21.5	B	For M6 bolt
DT 12100	12	100	329	172	219	28.6	B	For M8 bolt
DT 12120	12	120	410	176	226	32	B	For M8 bolt
DT 12150	12	150	486	171	243	40	B	For M8 bolt
DT 12200	12	200	523	240	224	54	F	For M8 bolt

*Capacitance is indicated at the 20-hour discharge.

DTS FOR LOW CURRENT SYSTEMS

Sealed maintenance-free lead-acid batteries series DTS DELTA brand are manufactured by AGM technology (electrolyte absorbed in glass fiber separators) and equipped with VRLA valves.

Due to a wide range of batteries and their high performance, are recommended for use in a variety of uninterruptible power supply systems, including exacting electrical appliances (submersible and circulation pumps, boilers of heating systems), emergency power supply and other electrical devices.

Scopes of application:

- Uninterruptible power supply;
- Back up power supply;
- Space-heating system;
- Renewable energy systems.



Service life	In buffer mode	up to 40Ah – 5 years, over 65Ah – 7-10 years
	In cyclic mode	up to 40Ah – 1000 cycles at 30% discharge depth, over 65Ah – 1100 cycles at 30% discharge depth.
Self-discharge	Less than 3% per month	
Charging method	DC voltage charging	25°C
	Cyclic mode	2,4-2,45 V/cell Temperature compensation - 5 mV/cell°C
	Buffer mode	2,25-2,3 V/cell Temperature compensation - 3.3 mV/cell°C

Terminal diagrams

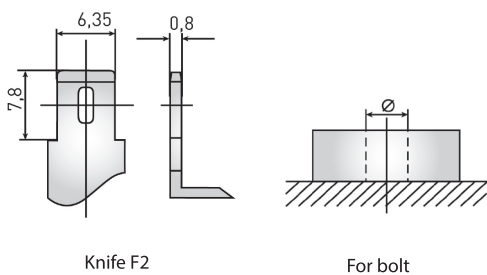

Battery construction

Component	Positive plate	Negative plate	Container	Cover	Valve	Terminals	Separator	Electrolyte
Material	Lead dioxide	Lead	ABS	ABS	Rubber	Copper	Fiberglass	Acid

Housing types

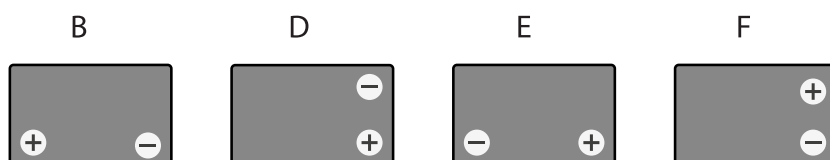



TEMPERATURE INFLUENCE ON THE CAPACITANCE

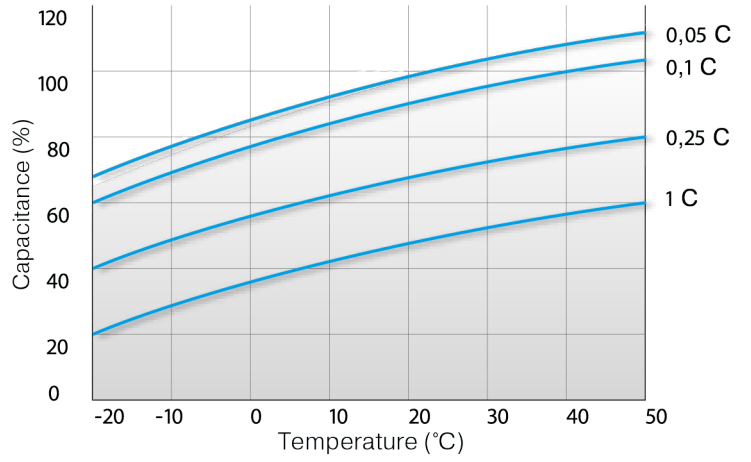

SERVICE LIFE IN CYCLIC MODE

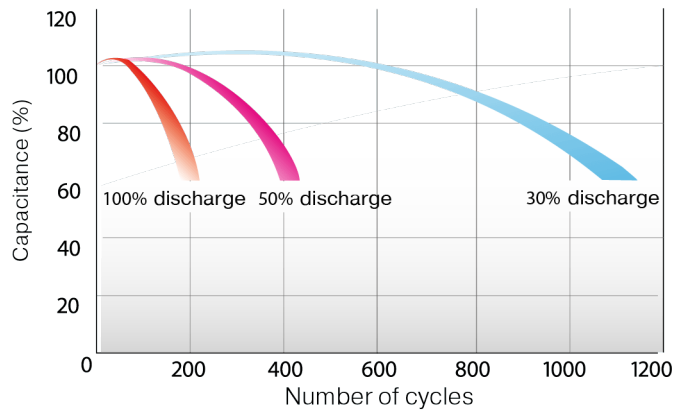

DISCHARGE CHARACTERISTICS

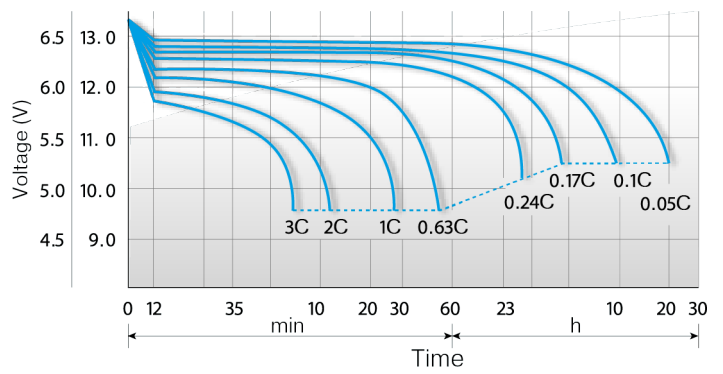

SERVICE LIFE IN BUFFER MODE (5 YEARS)

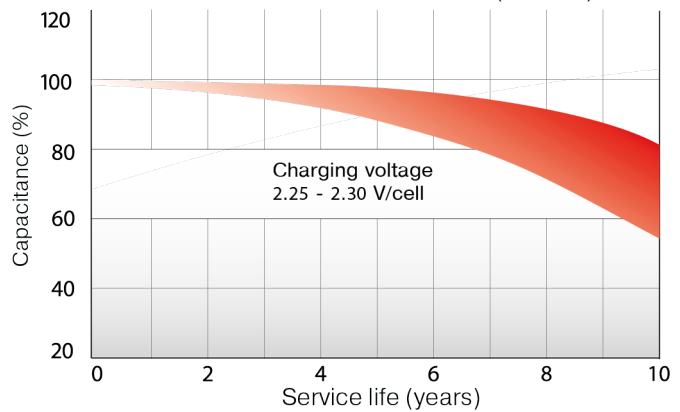

Standard sizes

Type (Old)	Voltage, V	Capacitance, Ah*	Length (±2), mm	Width (±2), mm	Height max (±2), mm	Weight, kg	Body	Terminal type
DTS 1205	12	5,00	90	70	105	1,7	B	F2 type terminal
DTS 1207	12	7,20	151	65	100	2,3	D	F2 type terminal
DTS 1209	12	9,00	151	65	100	2,6	D	F2 type terminal
DTS 1212	12	12,00	151	98	100	3,55	F	F2 type terminal
DTS 1218	12	18,00	181	77	167	5,4	E	Insert Ø5 mm
DTS 1226	12	26,00	166	125	175	8,2	E	Insert Ø5 mm
DTS 1233	12	33,00	195	130	167	10	B	Insert Ø6 mm
DTS 1240	12	40,00	198	166	176	12,6	E	Insert Ø6 mm
DTS 1255	12	55,00	229	138	216	16	B	Insert Ø6 mm
DTS 1265	12	65,00	350	167	174	19	B	Insert Ø6 mm
DTS 1275	12	75,00	260	167	215	21	B	Insert Ø6 mm
DTS 1290	12	90,00	306	169	215	26	B	Insert Ø6 mm
DTS 12100	12	100,00	330	173	222	28	B	Insert Ø6 mm
DTS 12120	12	120,00	409	176	226	32,5	B	Insert Ø8 mm
DTS 12140	12	140,00	340	173	285	40	B	Insert Ø8 mm
DTS 12150	12	150,00	483	170	240	43,5	B	Insert Ø8 mm
DTS 12200	12	200,00	522	239	222	58	F	Insert Ø8 mm

*Capacitance is indicated at the 20-hour discharge.

Discharge characteristics

Type	DC discharge up to 1.70 V/cell, A, at t 25°C.						Discharge with constant power up to 1.70 V/cell, W/cell, at t 25°C					
	5 min	15 min	30 min	1 hour	3 hours	5 hours	5 min	15 min	30 min	1 hour	3 hours	5 hours
DTS 1205	16,5	8,39	4,87	2,92	1,24	0,86	29,3	15,6	8,70	5,52	2,38	1,62
DTS 1207	24,8	13,1	7,36	4,06	1,67	1,19	45,9	23,8	13,5	8,08	3,33	2,16
DTS 1209	33,0	15,4	9,23	5,49	2,08	1,40	59,0	29,6	17,4	10,5	4,05	2,74
DTS 1212	44,3	23,6	13,7	7,58	2,7	1,72	79,3	43,5	26,4	14,7	5,39	3,55
DTS 1218	66,4	35,4	20,5	12,1	4,92	3,18	119	65,3	39,5	23,6	9,8	6,33
DTS 1226	91,1	46,5	28,1	15,2	7,01	4,57	163	81,7	52,2	29,1	13,7	8,1
DTS 1233	101	50,1	29,5	21,0	8,42	5,87	186	91,1	58,8	34,7	16,1	11,4
DTS 1240	104	63,9	36,5	23,5	9,79	6,92	190	109	72,4	46,5	19,4	13,1
DTS 1255	145	87,1	52,4	37,1	12,9	9,01	273	161	98,9	63,4	25,8	17,4
DTS 1265	179	110	63,6	36,8	15,7	10,8	322	188	110	69,5	30,8	21,5
DTS 1275	196	118	75,4	44,0	19,3	12,8	371	226	144	85,6	35,9	25,1
DTS 1290	235	137	84,0	49,7	22,2	15,2	464	245	159	97,4	44,5	30,4
DTS 12100	245	147	88,6	57,2	25,5	17,0	472	293	168	103	47,9	33,2
DTS 12120	296	182	108	70,7	28,5	19,2	525	337	207	133	56,3	39,2
DTS 12140	385	234	147	85,9	35,7	23,9	682	434	281	166	74,2	49,3
DTS 12150	400	249	157	91,3	37,0	25,0	713	465	303	175	74,8	50,4
DTS 12200	495	309	190	115	51,4	34,4	842	571	357	219	101	68,7

DTM

UNIVERSAL BATTERIES

DELTA lead-acid batteries of the DTM series are sealed, maintenance-free with a gas recombination system (VRLA). They are manufactured using AGM technology (Absorbent Glass Mat - an electrolyte absorbed in a fiberglass separator).

The DTM series is universal and is recommended for use in both buffer and cyclic operation - in various portable devices as well as in stationary systems with back-up power.

Scopes of application:

- Sources of backup power supply
- Uninterruptible power supplies
- Electronic cash registers
- Medical equipment
- Portable and mobile devices
- Different areas of instrumentation
- Control and access systems
- Alarm systems



Service life	In buffer mode	6 years
	In cyclic mode	1200 cycles at 30% discharge depth
Self-discharge	Less than 3% per month	
Charging method	DC voltage charging	25°C
	Cyclic mode	2,35-2,4 V/cell Temperature compensation - 5 mV/cell°C
	Buffer mode	2,25-2,3 V/cell Temperature compensation - 3.3 mV/cell°C

Terminal diagrams

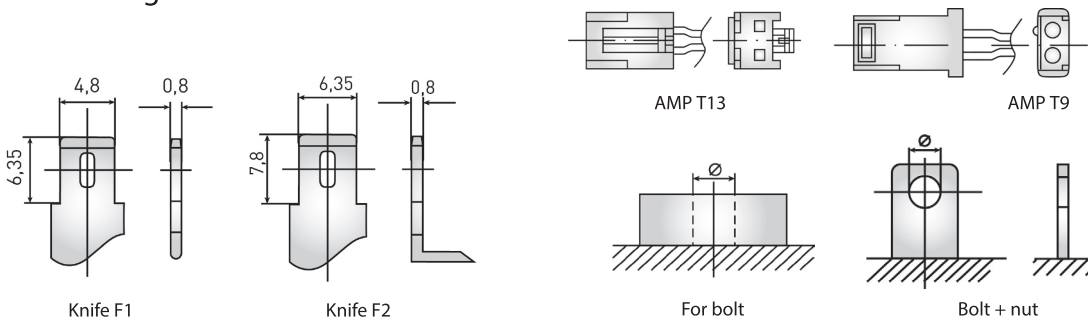

Battery construction

Component	Positive plate	Negative plate	Container	Cover	Valve	Terminals	Separator	Electrolyte
Material	Lead dioxide	Lead	ABS	ABS	Rubber	Copper	Fiberglass	Sulfuric acid

Housing types

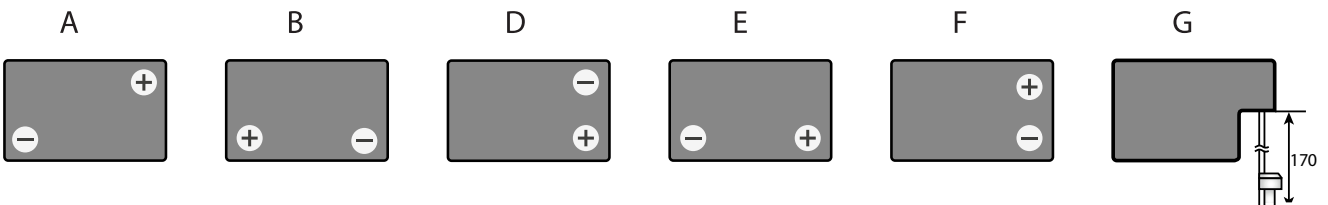

TEMPERATURE INFLUENCE ON THE CAPACITANCE

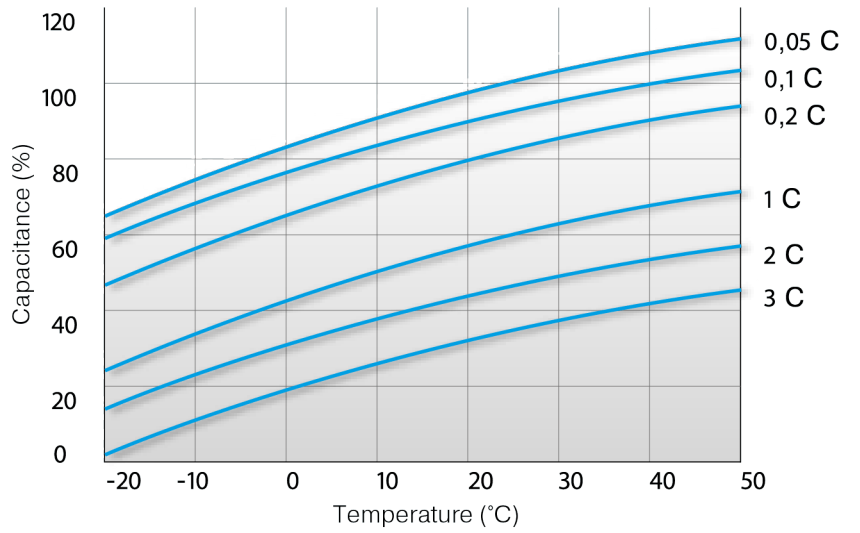

SERVICE LIFE IN CYCLIC MODE

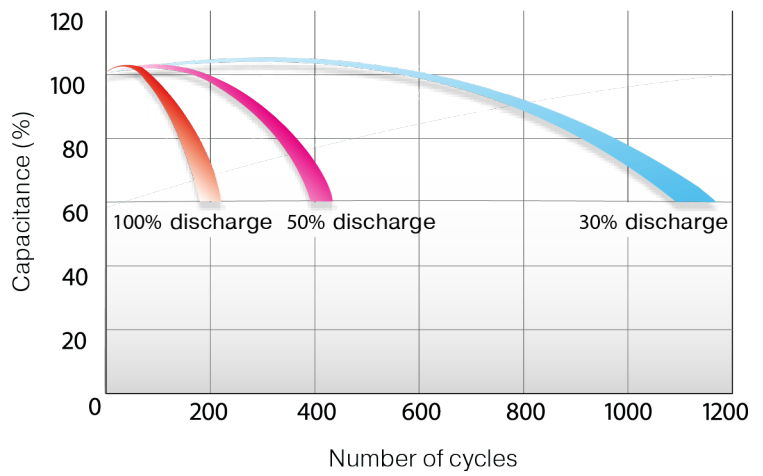

SERVICE LIFE IN BUFFER MODE

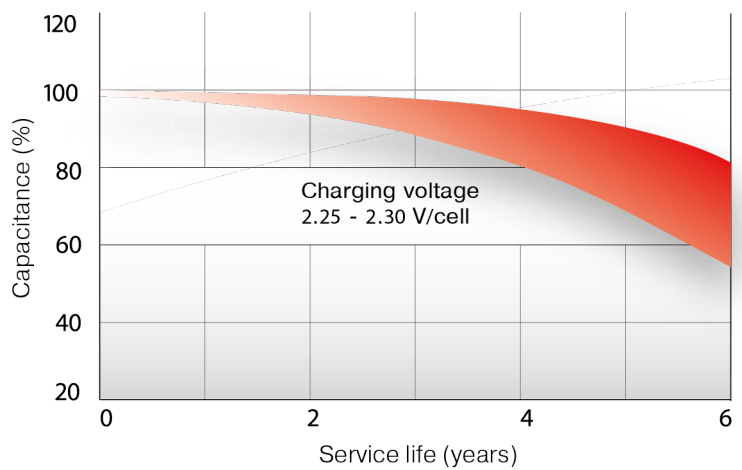

Standard sizes

Type	Voltage, V	Capacitance, Ah*	Length (±2), mm	Width (±2), mm	Height (±2) max, mm	Weight, kg	Body	Terminal type
DTM 6012	6	1.2	97	24	58	0.31	B	Knife F1
DTM 6032	6	3.2	134	34	67	0.65	B	Knife F1
DTM 6045	6	4.5	70	47	107	0.78	A	Knife F1
DTM 607	6	7	151	34	100	1.2	B	Knife F1
DTM 612	6	12	151	50	100	1.7	B	Knife F1
DTM 12008	12	0.8	96	25	62	0.4	G	AMP
DTM 12012	12	1.2	97	43	58	0.61	F	Knife F1
DTM 12022	12	2.2	178	35	67	1	B	Knife F1
DTM 12032	12	3.2	134	67	67	1.35	F	Knife F1
DTM 12045	12	4.5	90	70	107	1.6	B	Knife F1
DTM 1205	12	5	90	70	107	1.8	B	Knife F1
DTM 1207	12	7.2	151	65	100	2.4	D	Knife F2
DTM 1209	12	9	151	65	100	2.65	D	Knife F2
DTM 1212	12	12	151	98	101	3.8	D	Knife F2
DTM 1215	12	14.5	151	98	98	4.2	D	Knife F2
DTM 1217	12	17	181	77	167	5.6	E	Bolt + nut Ø 5.5
DTM 1226	12	26	166	175	125	9	F	For M5 bolt

*Capacitance is indicated at the 20-hour discharge.

Discharge characteristics

Type	DC discharge up to 1.70 V/cell, A, at t 25°C.						Discharge with constant power up to 1.70 V/cell, W/cell, at t 25°C					
	5 min	15 min	30 min	1 hour	3 hours	5 hours	5 min	15 min	30 min	1 hour	3 hours	5 hours
DTM 6012	4.36	2.27	1.31	0.75	0.35	0.21	6.93	4.33	2.50	1.47	0.65	0.48
DTM 6032	11.6	5.55	3.40	1.94	0.83	0.59	20.2	10.6	6.44	3.75	1.72	1.19
DTM 6045	14.3	8.19	4.41	2.83	1.16	0.74	28.0	15.5	8.69	5.30	2.34	1.53
DTM 607	25.5	13.4	7.70	4.57	1.75	1.25	50.0	26.7	15.3	9.12	3.50	2.20
DTM612	34.0	18.2	9.82	6.11	2.55	1.80	62.2	35.6	21.2	12.5	5.05	3.61
DTM 12008	3.08	1.44	0.88	0.5	0.21	0.14	5.48	2.66	1.64	0.95	0.40	0.27
DTM 12012	5.12	2.43	1.36	0.83	0.36	0.24	8.67	4.58	2.64	1.64	0.69	0.47
DTM 12022	8.27	4.13	2.29	1.29	0.54	0.39	16.0	7.86	4.28	2.28	0.98	0.73
DTM 12032	11.5	5.5	3.36	1.92	0.82	0.58	20.0	10.4	6.38	3.71	1.63	1.15
DTM 12045	13.6	7.97	4.25	2.74	1.12	0.71	26.6	15.2	8.28	4.77	2.23	1.41
DTM 1205	18.8	9.10	5.05	3.01	1.30	0.88	30.7	16.4	9.10	5.80	2.49	1.74
DTM 1207	26.0	13.6	7.62	4.22	1.74	1.17	46.9	25.4	14.0	8.23	3.40	2.25
DTM1209	42.8	15.8	9.36	5.56	2.12	1.45	74.8	30.1	17.9	11.0	4.13	2.80
DTM 1212	57.1	26.3	14.2	7.63	2.76	1.79	94.0	51.7	28.3	15.0	5.47	3.57
DTM 1215	58.8	28.3	16.4	8.52	3.0	2.11	107	54.0	29.6	15.8	5.85	4.10
DTM 1217	62.2	32.6	19.3	11.6	4.5	3.00	110	58.5	35.0	21.5	8.92	5.99
DTM 1226	98.3	47.3	28.5	15.7	7.10	4.64	173	85.8	52.9	31.0	12.9	8.18

DTM L

UNIVERSAL BATTERIES

DELTA lead-acid batteries of the DTM L series are sealed, maintenance-free with a gas recombination system (VRLA). They are manufactured using AGM technology (Absorbent Glass Mat - an electrolyte absorbed in a fiberglass separator).

The DTM L Series belongs to the Long Life range with a lifetime of up to 12 years.

Scopes of application:

- Sources of backup power supply
- Uninterruptible power supplies
- Medical equipment
- Wheelchairs
- Pumps, boilers of heating systems
- Solar and wind power systems

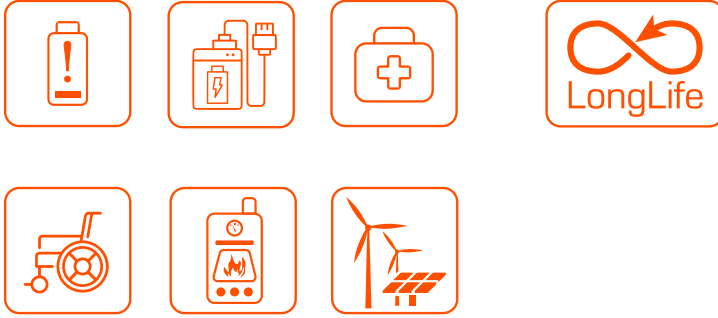

Service life	In buffer mode	10-12 years
	In cyclic mode	1250 cycles at 30% discharge depth
Self-discharge	Less than 3% per month	
Charging method	DC voltage charging	25°C
	Cyclic mode	2,35-2,4 V/cell Temperature compensation - 5 mV/cell°C
	Buffer mode	2,25-2,3 V/cell Temperature compensation - 3.3 mV/cell°C

Terminal diagrams

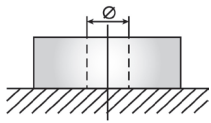

For bolt

Battery construction

Component	Positive plate	Negative plate	Container	Cover	Valve	Terminals	Separator	Electrolyte
Material	Lead dioxide	Lead	ABS	ABS	Rubber	Copper	Fiberglass	Sulfuric acid

Housing types

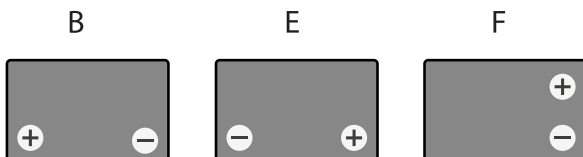



TEMPERATURE INFLUENCE ON THE CAPACITANCE

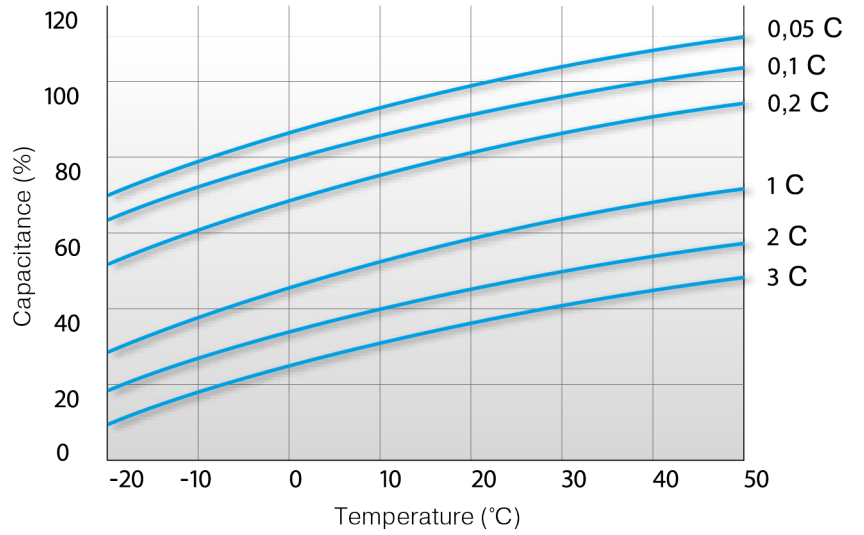

SERVICE LIFE IN CYCLIC MODE

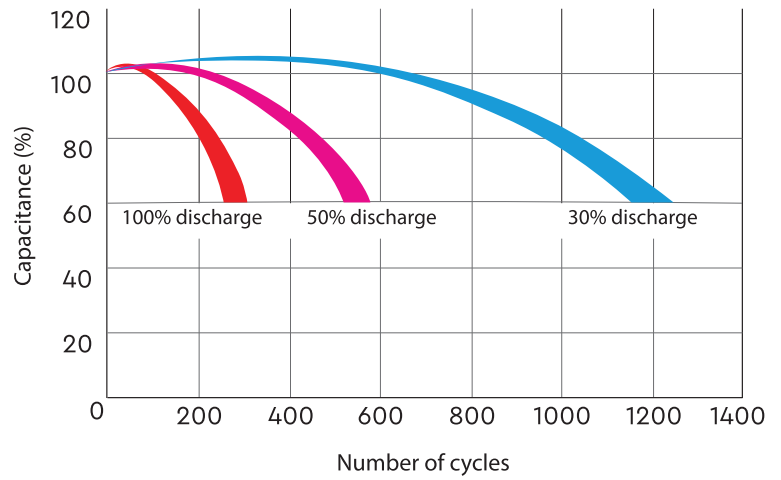

SERVICE LIFE IN BUFFER MODE

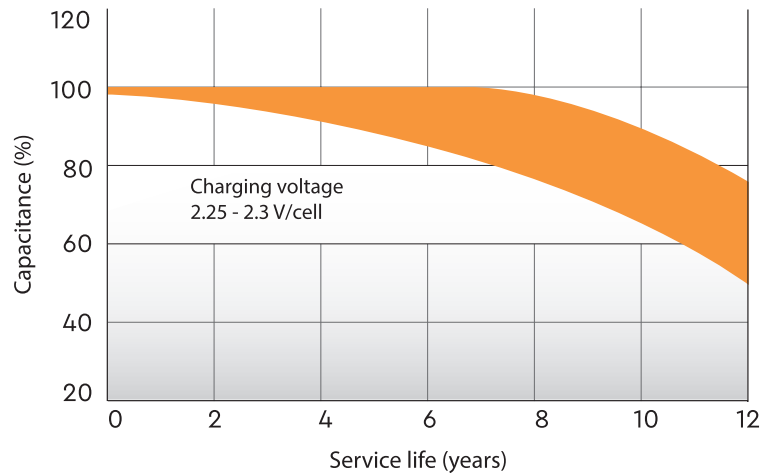

Standard sizes

Type	Voltage, B	Capacitance*, Ah	Length (±2), mm	Width (±2), mm	Height max (±2), mm	Weight, kg	Body	Terminal type
DTM 1233 L	12	33	195	130	168	10.1	B	For M6 bolt
DTM 1240 L	12	40	198	166	170	14	E	For M6 bolt
DTM 1255 L	12	55	239	132	210	16.2	B	For M6 bolt
DTM 1265 L	12	65	350	167	179	22.4	B	For M6 bolt
DTM 1275 L	12	75	258	166	215	23	B	For M6 bolt
DTM 1290 L	12	90	306	169	216	27	B	For M6 bolt
DTM 12100 L	12	100	330	171	220	29	B	For M6 bolt
DTM 12120 L	12	120	410	176	224	34	B	For M8 bolt
DTM 12150 L	12	150	482	170	240	45	B	For M8 bolt
DTM 12200 L	12	200	522	238	223	59	F	For M8 bolt
DTM 12230 L	12	230	520	269	208	72.6	F	For M8 bolt
DTM 12250 L	12	250	520	269	227	74	F	For M8 bolt

*Capacitance is indicated at the 10-hour discharge.

Discharge characteristics

Type	DC discharge up to 1.70 V/cell, A, at t 25°C.						Discharge with constant power up to 1.70 V/cell, W/cell, at t 25°C					
	10 min	15 min	30 min	1 hour	3 hours	5 hours	10 min	15 min	30 min	1 hour	3 hours	5 hours
DTM 1233 L	64.8	51.4	30.4	21.2	8.45	6.15	119	95.7	60.0	39.9	16.8	11.5
DTM 1240 L	77.8	64.5	37.3	24.2	9.89	6.97	144	117	76.3	48.3	20.3	13.6
DTM 1255 L	115	90.6	55.6	33.3	13.9	9.40	213	169	107	65.8	27.9	18.2
DTM 1265 L	138	110	64.3	41.0	16.1	11.0	243	190	117	75.3	32.4	21.8
DTM 1275 L	158	122	77.0	46.9	21.0	13.9	290	237	145	89.8	38.9	26.0
DTM 1290 L	183	145	86.4	51.3	23.0	15.7	350	281	163	99.0	45.1	30.9
DTM12100L	185	153	90.6	58.6	26.2	17.3	354	297	173	109	48.9	33.7
DTM 12120 L	231	193	110	71.3	28.7	19.7	414	343	211	143	56.6	40.2
DTM 12150 L	303	254	167	94.1	39.3	25.3	560	470	308	178	75.2	51.0
DTM 12200 L	400	337	206	120	55.0	36.6	704	586	382	221	105	71.2
DTM 12230 L	436	365	240	150	67.8	44.9	809	666	462	291	129	86.1
DTM 12250 L	517	436	265	158	72.0	47.0	898	784	488	299	138	91.0

HR UPS SERIES

DELTA lead-acid batteries of the HR series are sealed, maintenance-free with a gas recombination system (VRLA). They are manufactured using AGM technology (Absorbent Glass Mat - an electrolyte absorbed in a fiberglass separator). Thanks to this technology, the batteries have excellent discharge characteristics.

The HR series belongs to the ASTERION UPS series, designed specifically for use in uninterruptible power supplies. Data center, in communication systems and other equipment.

Scopes of application:

- Sources of backup power supply
- Uninterruptible power supplies
- Medical equipment
- Different areas of instrumentation
- Solar and wind power systems

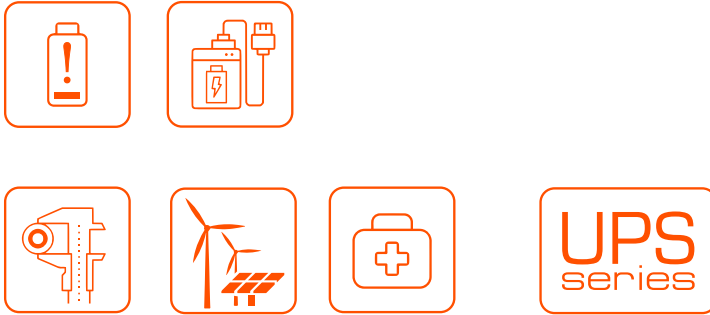

Service life	In buffer mode	up to 26 Ah inclusive – 8 years Delta HR 12-40, HR 12-65, HR 12-100 – 10-12 years old
	In cyclic mode	Up to 26Ah inclusive – 1200 cycles at 30% discharge depth. Delta HR 12-40, HR 12-65, HR 12-100 – 1300 cycles at 30% discharge depth
Self-discharge		Less than 3% per month
Charging method	DC voltage charging	25°C
	Cyclic mode	2,35-2,4 V/cell Temperature compensation - 5 mV/cell°C
	Buffer mode	2,25-2,3 V/cell Temperature compensation - 3.3 mV/cell°C

Terminal diagrams

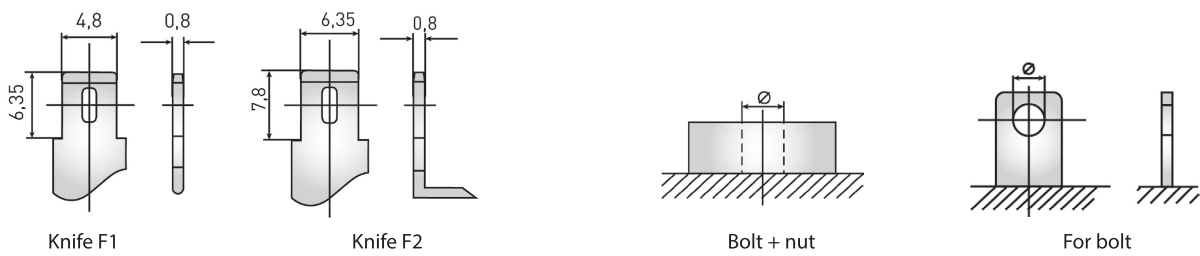

Battery construction

Component	Positive plate	Negative plate	Container	Cover	Valve	Terminals	Separator	Electrolyte
Material	Lead dioxide	Lead	ABS	ABS	Rubber	Copper	Fiberglass	Sulfuric acid

Housing types

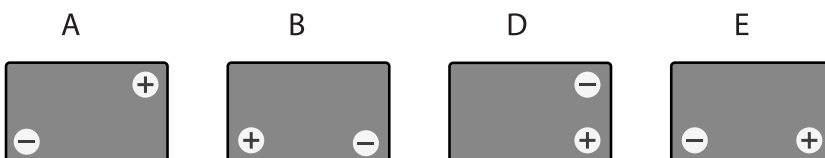

TEMPERATURE INFLUENCE ON THE CAPACITANCE

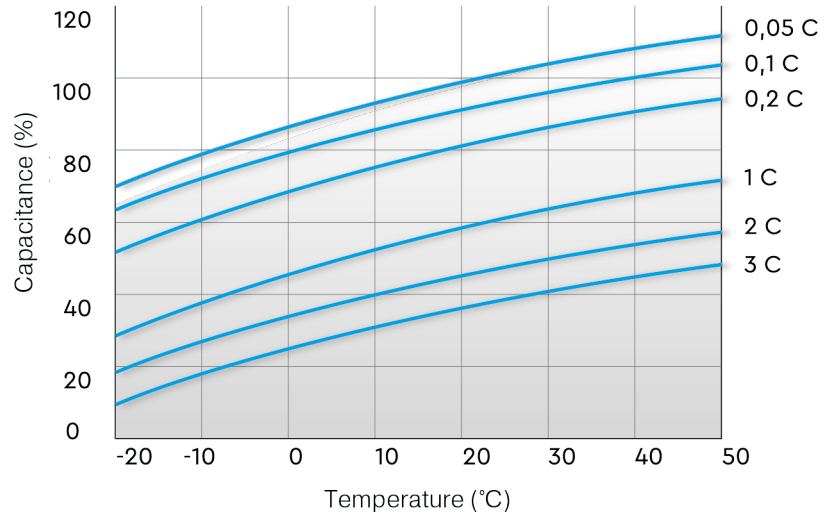

SERVICE LIFE IN CYCLIC MODE (Up to 26 Ah)

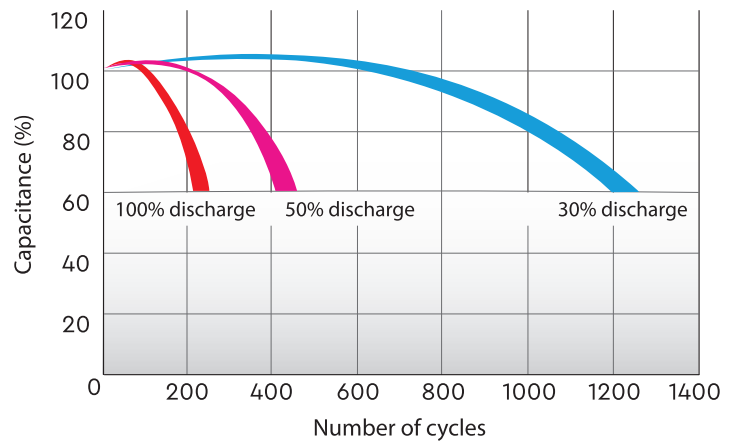

SERVICE LIFE IN BUFFER MODE (8 YEARS)

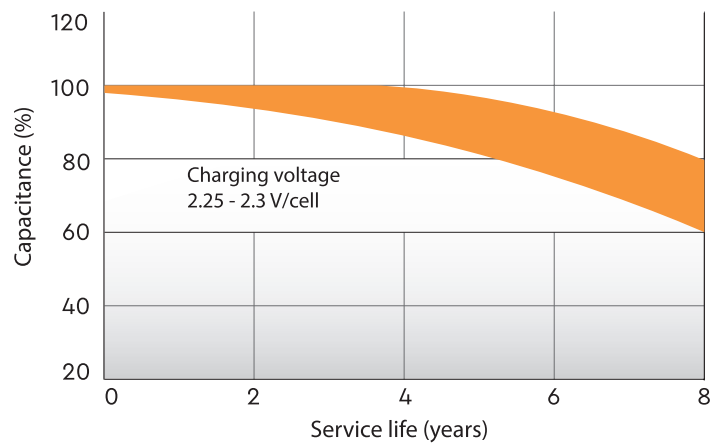

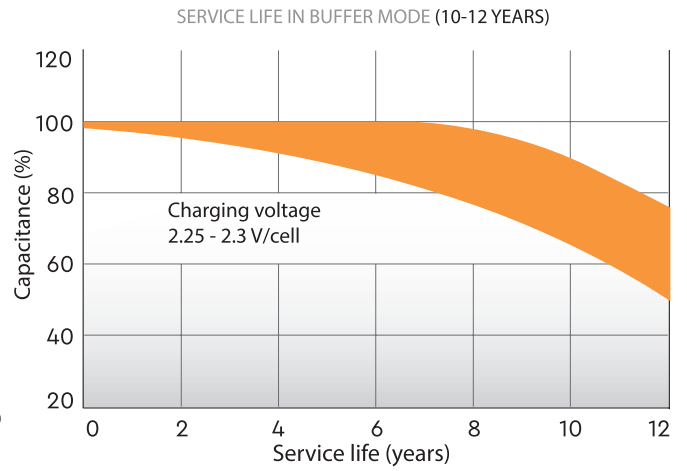
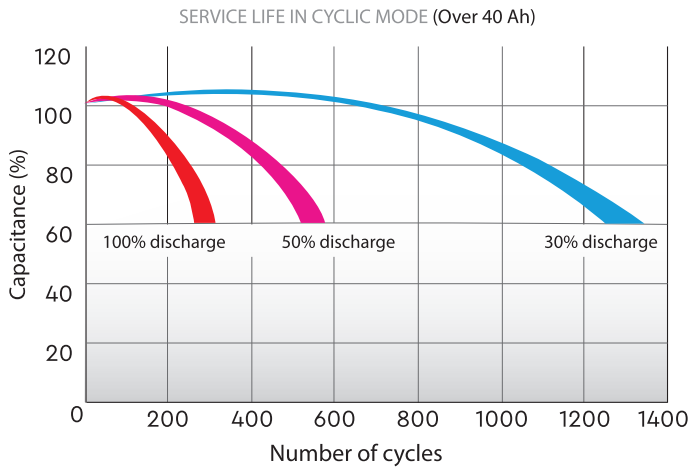

Standard sizes

Type	Voltage, V	Capacitance, Ah*	Length (±2), mm	Width (±2), mm	Height max (±2), mm	Weight, kg	Body	Terminal type
HR 6-4.5	6	4.5	70	47	107	0.85	A	Knife F1
HR 6-7.2	6	7.2	151	34	100	1.28	B	Knife F1
HR 6-9	6	8.8	151	34	100	1.37	B	Knife F1
HR 6-12	6	12	151	50	100	1.85	B	Knife F1
HR 6-15	6	15	151	50	100	1.95	B	Knife F1
HR 12-4.5	12	4.5	90	70	107	1.75	B	Knife F1
HR 12-5	12	5	90	70	107	1.8	B	Knife F2
HR 12-5.8	12	5.4	90	70	107	1.95	B	Knife F2
HR 12-7.2	12	7.2	151	65	100	2.5	D	Knife F2
HR 12-9	12	9	151	65	100	2.78	D	Knife F2
HR 12-12	12	12	151	98	101	3.72	D	Knife F2
HR 12-15	12	15	151	98	101	4.6	D	Knife F2
HR 12-18	12	18	181	77	167	6.1	E	Bolt + nut Ø 5.5 mm
HR 12-26	12	26**	165	125	175	9.3	E	For M5 bolt
HR 12-40	12	45**	198	166	170	14.8	E	For M6 bolt
HR 12-65	12	65**	350	167	179	23.4	B	For M6 bolt
HR 12-100	12	100**	330	171	220	32	B	For M6 bolt

*Capacitance is indicated at the 20-hour discharge.

**Capacitance is indicated at the 10-hour discharge.

Discharge characteristics

Type	DC discharge up to 1.70 V/cell, A, at t 25°C.						Discharge with constant power up to 1.70 V/cell, W/cell, at t 25°C					
	5 min	15 min	30 min	1 hour	3 hours	5 hours	5 min	15 min	30 min	1 hour	3 hours	5 hours
HR 6-4.5	15.7	9.01	4.85	3.12	1.28	0.81	29.2	16.6	9.89	6.09	2.46	1.67
HR 6-7.2	25.5	13.4	7.70	4.57	1.75	1.25	50.0	26.7	15.3	9.11	3.50	2.20
HR 6-9	33.0	15.5	9.70	5.68	2.25	1.52	64.9	35.6	20.2	11.4	4.46	2.90
HR 6-12	44.7	22.8	12.4	7.22	3.10	2.08	77.1	42.5	24.5	14.4	6.22	4.10
HR 6-15	43.6	22.4	12.6	8.84	3.64	2.38	81.0	42.6	24.0	16.3	6.66	4.12
HR 12-4.5	19.7	10.0	5.41	3.33	1.35	0.88	36.7	16.4	9.56	5.84	2.55	1.68
HR 12-5	24.3	11.9	6.62	3.93	1.48	0.97	44.8	22.0	12.6	7.60	2.93	1.95
HR 12-5.8	25.0	12.8	7.06	4.07	1.62	1.02	49.1	24.9	14.1	8.10	3.26	1.99
HR 12-7.2	26.8	13.9	7.86	4.44	1.76	1.20	50.4	25.9	14.3	8.53	3.49	2.30
HR 12-9	33.1	17.7	10.5	6.18	2.46	1.59	66.9	32.9	20.0	11.5	4.74	3.21
HR 12-12	43.5	23.7	13.3	7.94	3.12	2.07	81.9	45.3	26.2	15.8	6.37	4.14
HR 12-15	63.9	31.9	18.6	10.6	4.04	2.55	113	58.3	34.5	19.2	7.42	4.58
HR 12-18	69.3	36.7	21.0	12.6	5.04	3.37	138	78.7	43.3	26.0	10.1	6.88
HR 12-26	100	51.0	30.9	19.2	7.86	4.95	183	95.3	58.2	35.7	15.9	10.0
HR 12-40	134	73.0	43.9	27.2	11.3	7.52	232	135	83.8	54.0	22.5	14.7
HR 12-65	191	114	66.3	41.5	16.9	11.5	337	197	118	77.2	33.7	22.4
HR 12-100	281	164	96.0	61.5	27.2	18.0	508	299	183	114	50.9	35.0

HR-W UPS SERIES

DELTA lead-acid batteries of the HR-W series are sealed, maintenance-free with a gas recombination system (VRLA). They are manufactured using AGM technology (Absorbent Glass Mat - an electrolyte absorbed in a fiberglass separator).

The HRL-W series is part of DELTA UPS series designed specifically for use in uninterruptible power supplies to data centers, communication systems, and other equipment. The HR-W series has improved energy efficiency due to thicker plates and a modified lead grating structure.

Scopes of application:

- Sources of backup power supply
- Uninterruptible power supplies
- Medical equipment
- Different areas of instrumentation
- Solar and wind power systems

HR-W

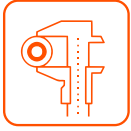

Service life	In buffer mode	8 years
	In cyclic mode	1200 cycles at 30% discharge depth
Self-discharge	Less than 3% per month	
Charging method	DC voltage charging	25°C
	Cyclic mode	2,35-2,4 V/cell Temperature compensation - 5 mV/cell°C
	Buffer mode	2,25-2,3 V/cell Temperature compensation - 3.3 mV/cell°C

Terminal diagrams

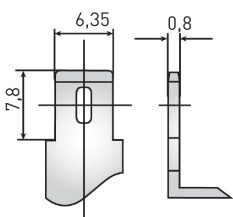

Knife F2

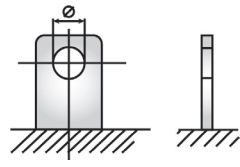

For bolt

Battery construction

Component	Positive plate	Negative plate	Container	Cover	Valve	Terminals	Separator	Electrolyte
Material	Lead dioxide	Lead	ABS	ABS	Rubber	Copper	Fiberglass	Sulfuric acid

Housing types

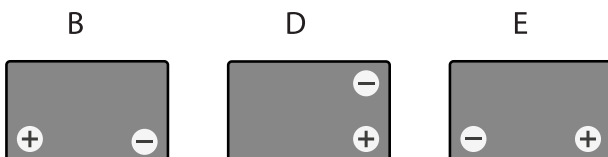

TEMPERATURE INFLUENCE ON THE CAPACITANCE

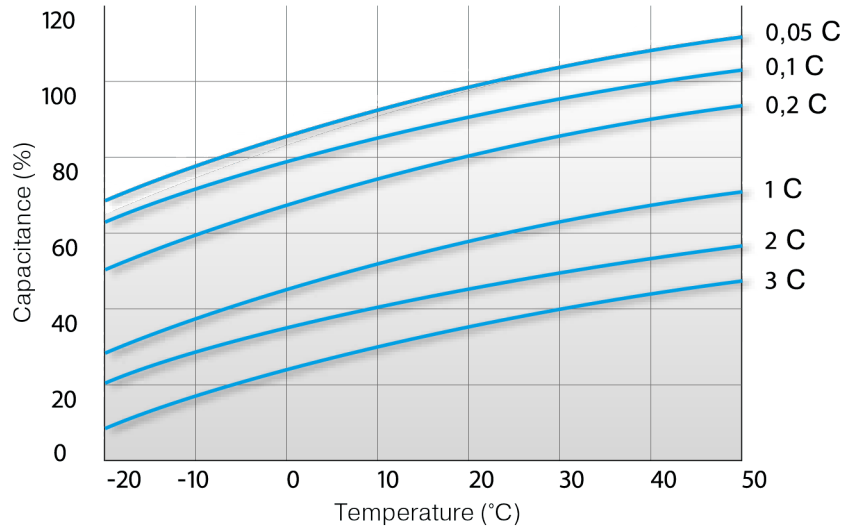

SERVICE LIFE IN CYCLIC MODE

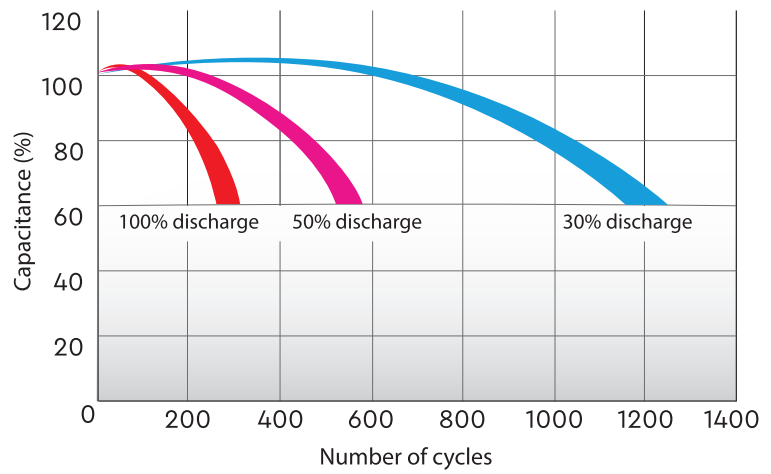

SERVICE LIFE IN BUFFER MODE

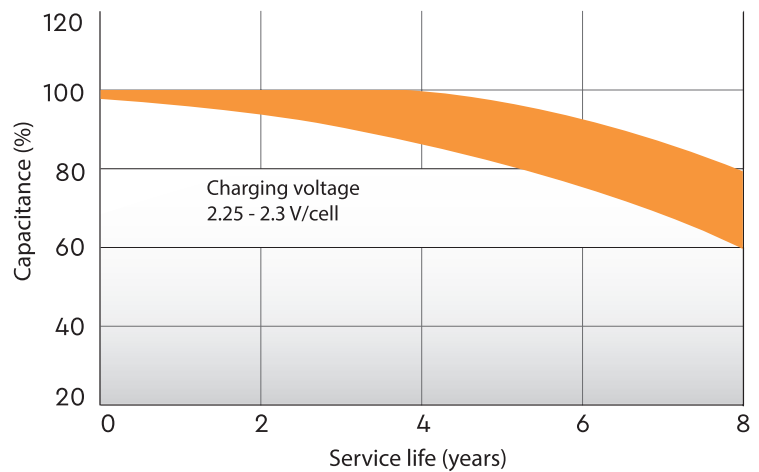

HR-W

Standard sizes

Type	Voltage, V	Capacitance, Ah*	Length (± 2), mm	Width (± 2), mm	Height max (± 2), mm	Weight, kg	Body	Terminal type
HR 12-21 W	12	5	90	70	107	1.8	B	Knife F2
HR 12-24 W	12	6	151	52	99	2.18	D	Knife F2
HR 12-28 W	12	7	151	65	100	2.2	D	Knife F2
HR 12-34 W	12	9	151	65	100	2.62	D	Knife F2
HR 12-51 W	12	12	151	98	101	3.8	D	Knife F2
HR 12-80 W	12	20	181	76	166	6.2	E	For M5 bolt

*Capacitance is indicated at the 20-hour discharge.

Discharge characteristics

Type	DC discharge up to 1.70 V/cell, A, at t 25°C.						Discharge with constant power up to 1.70 V/cell, W/cell, at t 25°C					
	5 min	15 min	30 min	1 hour	2 hours	3 hours	5 min	15 min	30 min	1 hour	2 hours	3 hours
HR 12-21 W	26.1	12.7	7.24	4.21	2.32	1.68	47.0	24.5	14.2	8.50	4.67	3.37
HR 12-24 W	28.7	15.0	8.51	4.68	2.65	1.94	53.0	27.1	15.8	8.88	5.39	4.06
HR 12-28 W	33.8	15.8	9.12	4.82	2.92	2.22	56.9	28.8	16.1	9.12	5.61	4.29
HR 12-34 W	37.0	18.1	9.9	5.61	3.47	2.73	68.1	34.1	19.3	10.9	6.77	5.35
HR 12-51 W	48.5	25.6	15.1	8.01	4.81	3.71	86.0	48.0	27.3	15.8	9.49	7.34
HR 12-80 W	87.0	48.9	27.7	15.2	8.35	6.04	164	83.5	50.1	28.5	15.8	11.4

HRL-X UPS SERIES

DELTA lead-acid batteries of the HRL-X series are sealed, maintenance-free with a gas recombination system (VRLA). They are manufactured using AGM technology (Absorbent Glass Mat - an electrolyte absorbed in a fiberglass separator). Thanks to optimized technology, the batteries have excellent discharge characteristics over the entire time interval range.

The HRL-X series is part of the DELTA UPS series designed specifically for use in uninterruptible power supplies to data centers, servers, communication systems, and other equipment. The series is highly reliable and has a service life of up to 12 years.

Scopes of application:

- Sources of backup power supply
- Uninterruptible power supplies
- Energy facilities
- Communication facilities
- Solar and wind power systems

HRL-X



Service life	In buffer mode	12 years
	In cyclic mode	1300 cycles at 30% discharge depth
Self-discharge		Less than 3% per month
Charging method	DC voltage charging	25°C
	Cyclic mode	2,35-2,4 V/cell Temperature compensation - 5 mV/cell°C
	Buffer mode	2,25-2,3 V/cell Temperature compensation - 3.3 mV/cell°C

Terminal diagrams

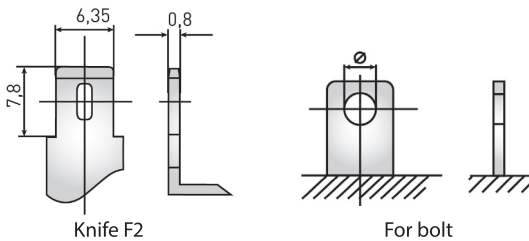

Battery construction

Component	Positive plate	Negative plate	Container	Cover	Valve	Terminals	Separator	Electrolyte
Material	Lead dioxide	Lead	ABS	ABS	Rubber	Copper	Fiberglass	Sulfuric acid

Housing types

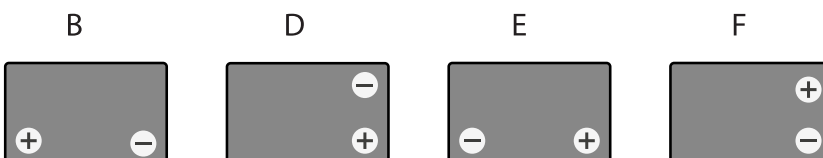

TEMPERATURE INFLUENCE ON THE CAPACITANCE

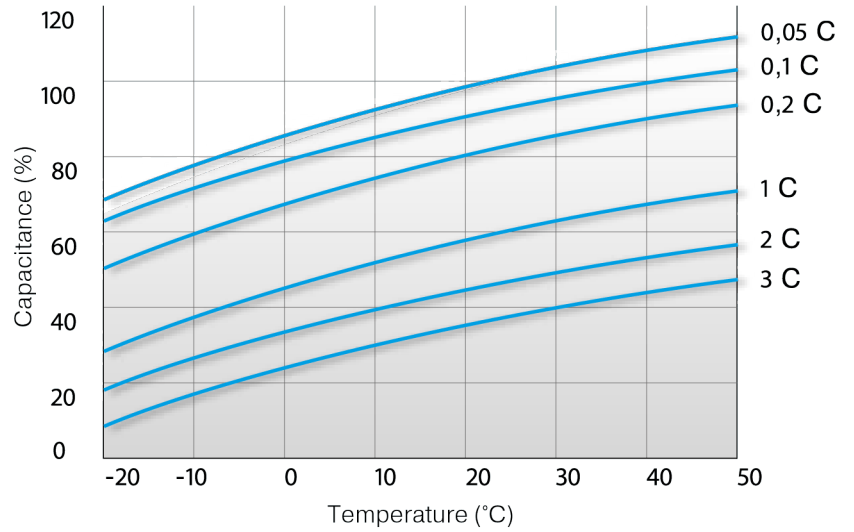

SERVICE LIFE IN CYCLIC MODE

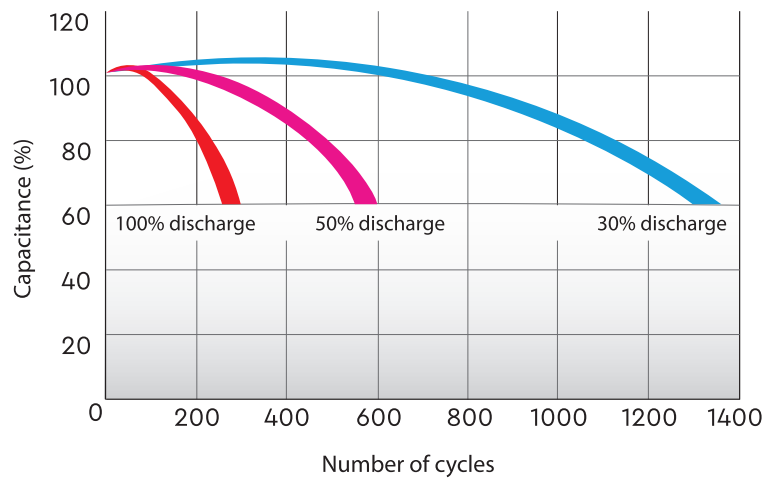

SERVICE LIFE IN BUFFER MODE

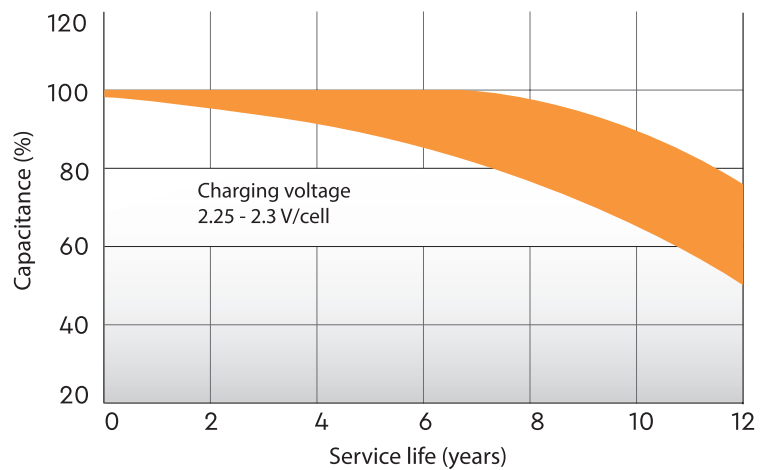

HRL-X

Standard sizes

Type	Voltage, V	Capacitance, Ah*	Length (±2), mm	Width (±2), mm	Height max (±2), mm	Weight, kg	Body	Terminal type
HRL 12-7.2 X	12	7.2	151	65	100	2.6	D	Knife F2
HRL 12-9 X (1234W)	12	9	151	65	100	2.55	D	Knife F2
HRL 12-12 X	12	12	151	98	101	3.85	D	Knife F2
HRL 12-18 X	12	17.8	181	77	167	6.2	E	Bolt + nut Ø 5.5mm
HRL 12-26 X	12	28	165	125	175	9.6	E	For M5 bolt
HRL 12-33 X	12	33	195	130	168	11.2	B	For M6 bolt
HRL 12-45 X	12	45	198	166	170	14.8	E	For M6 bolt
HRL 12-55 X	12	55	229	138	213	18.2	B	For M6 bolt
HRL 12-65 X	12	65	350	167	179	23.4	B	For M6 bolt
HRL 12-75 X	12	75	258	166	215	23.8	B	For M6 bolt
HRL 12-80 X	12	80	350	167	179	24.2	B	For M6 bolt
HRL 12-90 X	12	90	306	169	215	27.8	B	For M6 bolt
HRL 12-100 X	12	100	330	171	220	33	B	For M6 bolt
HRL 12-140 X	12	140	342	173	287	40	B	For M8 bolt
HRL 12-180 X	12	180	522	238	223	62	F	For M8 bolt

*Capacitance is indicated at the 10-hour discharge.

Discharge characteristics

Type	DC discharge up to 1.70 V/cell, A, at t 25°C.						Discharge with constant power up to 1.70 V/cell, W/cell, at t 25°C					
	5 min	15 min	30 min	1 hour	3 hours	5 hours	5 min	15 min	30 min	1 hour	3 hours	5 hours
HRL 12-7.2 X	25.4	13.9	7.86	4.44	1.76	1.20	46.2	25.9	14.3	8.53	3.49	2.30
HRL 12-9 X (1234W)	30.9	16.1	9.36	5.71	2.25	1.55	64.8	31.1	18.5	11.0	4.20	2.98
HRL 12-12 X	42.6	23.2	13.1	7.86	3.09	2.07	80.3	44.4	25.9	15.6	6.31	4.10
HRL 12-18 X	71.7	38.0	21.7	13.1	5.23	3.50	142	80.2	43.9	26.4	10.4	6.94
HRL 12-26 X	99.1	54.8	32.7	21.2	8.66	5.37	184	101	60.0	36.6	17.0	11.0
HRL 12-33 X	103	56.7	34.5	21.1	8.79	6.40	187	111	67.1	41.5	17.5	12.0
HRL 12-45 X	139	76.9	46.1	27.9	11.9	8.16	256	143	84.5	55.9	22.6	15.6
HRL 12-55 X	155	90.6	55.6	33.3	13.9	9.40	281	169	107	65.8	27.9	18.2
HRL 12-65 X	191	114	66.3	41.5	16.9	11.5	337	197	118	77.2	33.7	22.4
HRL 12-75 X	205	125	80.7	48.6	18.6	12.3	396	230	143	89.0	35.4	23.8
HRL 12-80 X	245	151	93.8	54.8	22.9	14.5	462	270	168	97.2	37.5	27.0
HRL 12-90 X	266	172	106	61.7	25.0	16.6	485	309	197	115	48.5	32.7
HRL 12-100 X	328	199	124	71.4	26.9	18.1	551	351	227	133	51.9	35.4
HRL 12-140 X	387	231	142	82.1	36.8	24.3	686	427	258	154	69.5	45.9
HRL 12-180 X	488	276	188	124	56.7	37.9	850	507	349	235	109	73.5

DTX FOR LOW CURRENT SYSTEMS

DELTA DTX Series Lead Acid Batteries are designed for use in renewable energy-based power systems, including solar and wind energy, autonomous energy supply systems. The batteries are sealed and maintenance-free, with a service life of 10 years in a buffer mode. Manufactured by using GEL technology: during the production process(a gel solution of sulfuric acid gelled in a gel) is used as an electrolyte, which ensures high battery resistance to deep discharges (optimal when operating in a cyclic mode) and stable operation under conditions of ambient temperature changes.

Scopes of application:

- Uninterruptable power supply
- Back up power supply
- Communication system
- Renewable energy system
- Communication Power Racks

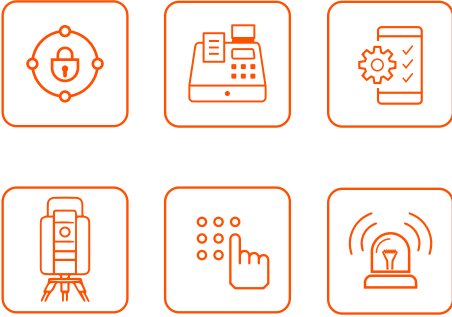

Service life	In buffer mode	10 years
	In cyclic mode	1800 cycles at 20% discharge depth
Self-discharge	Less than 3% per month	
Charging method	DC voltage charging	25°C
	Cyclic mode	2,4-2,5 V/cell Temperature compensation - 5 mV/cell°C
	Buffer mode	2,27-2,3 V/cell Temperature compensation - 3.3 mV/cell°C

Terminal diagrams

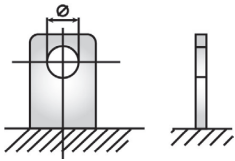

For bolt

Battery construction

Component	Positive plate	Negative plate	Container	Cover	Valve	Terminals	Separator	Electrolyte
Material	Lead dioxide	Lead	ABS	ABS	Rubber	Copper	Fiberglass	Acid

Housing types

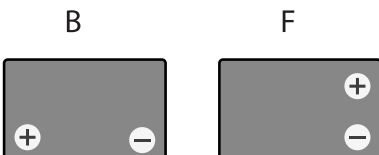



TEMPERATURE INFLUENCE ON THE CAPACITANCE

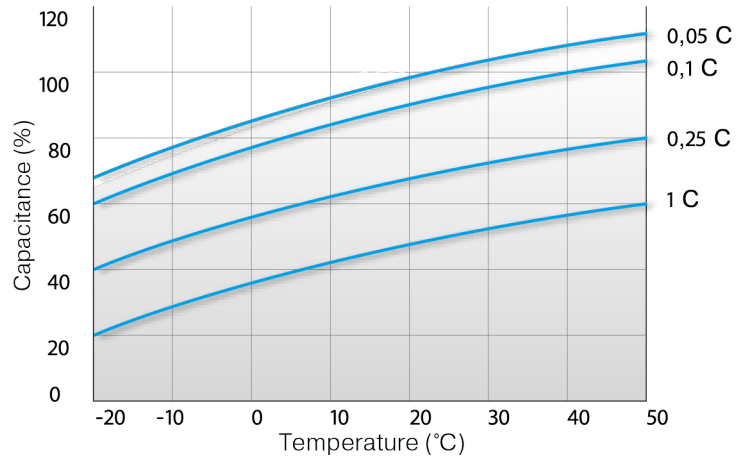

SERVICE LIFE IN CYCLIC MODE

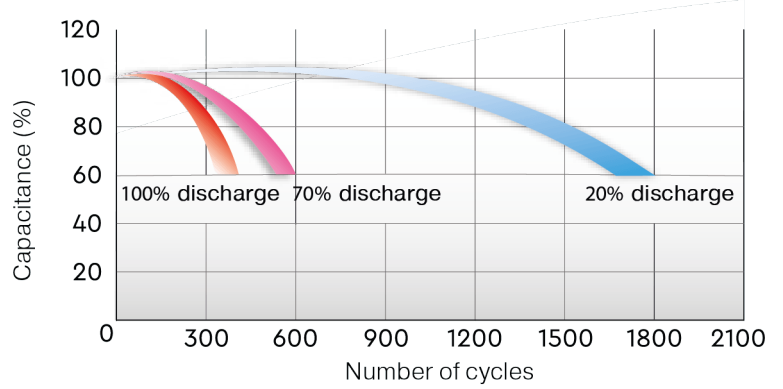

SERVICE LIFE IN BUFFER MODE

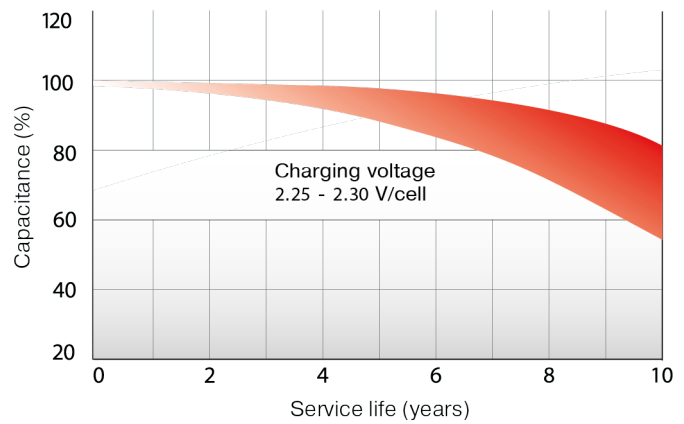

DISCHARGE CHARACTERISTICS

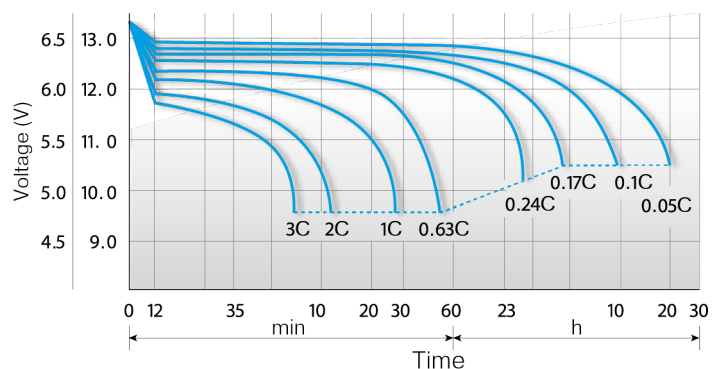

Standard sizes

Type (Old)	Voltage, V	Capacitance, Ah*	Length (±2), mm	Width (±2), mm	Height max (±2), mm	Weight, kg	Body	Terminal type
DTX 12100	12	100,00	330	171	220	30	B	Insert Ø6
DTX 12200	12	200,00	522	238	223	58	F	Insert Ø8

*Capacitance is indicated at the 20-hour discharge.

Discharge characteristics

Type	DC discharge up to 1.70 V/cell, A, at t 25°C.						Discharge with constant power up to 1.70 V/cell, W/cell, at t 25°C					
	5 min	15 min	30 min	1 hour	3 hours	5 hours	5 min	15 min	30 min	1 hour	3 hours	5 hours
DTX 12100	274	159	99,9	58,2	25,2	16,6	488	286	178	105	49,9	33,1
DTX 12200	461	292	191	111	46,8	34,5	823	533	351	208	94,1	65,0

GEL SOLAR SERIES

DELTA sealed lead-acid batteries of GEL series are manufactured according to AGM+GEL technology: combined AGM and GEL technology.

Recommended for use in autonomous power systems, in alternative energy systems.

Scopes of application:

- Uninterruptible power supplies
- Communication and telecommunication systems
- Solar and wind power systems
- Autonomous power supply systems
- Electromedical equipment, wheelchairs

GEL

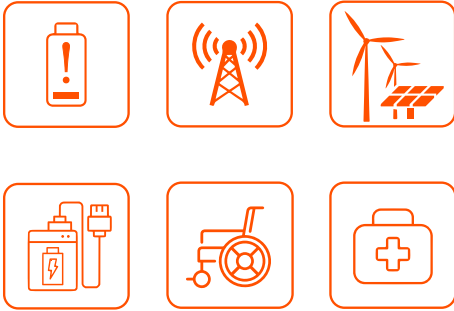

Service life	In buffer mode	10-12 years
	In cyclic mode	1400 cycles at 30% discharge depth
Self-discharge		Less than 3% per month
Charging method	DC voltage charging	25°C
	Cyclic mode	2,35-2,4 V/cell Temperature compensation - 5 mV/cell°C
	Buffer mode	2,25-2,3 V/cell Temperature compensation - 3.3 mV/cell°C

Terminal diagrams

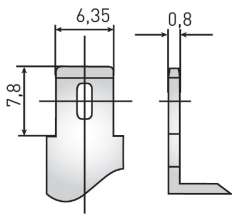

Knife F2

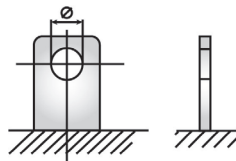

Bolt + nut

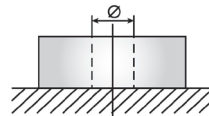

For bolt

Battery construction

Component	Positive plate	Negative plate	Container	Cover	Valve	Terminals	Separator	Electrolyte
Material	Lead dioxide	Lead	ABS	ABS	Rubber	Copper	Fiberglass	Sulfuric acid

Housing types

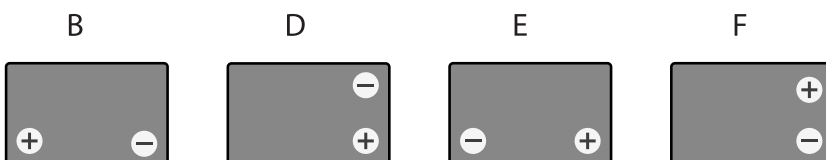



TEMPERATURE INFLUENCE ON THE CAPACITANCE

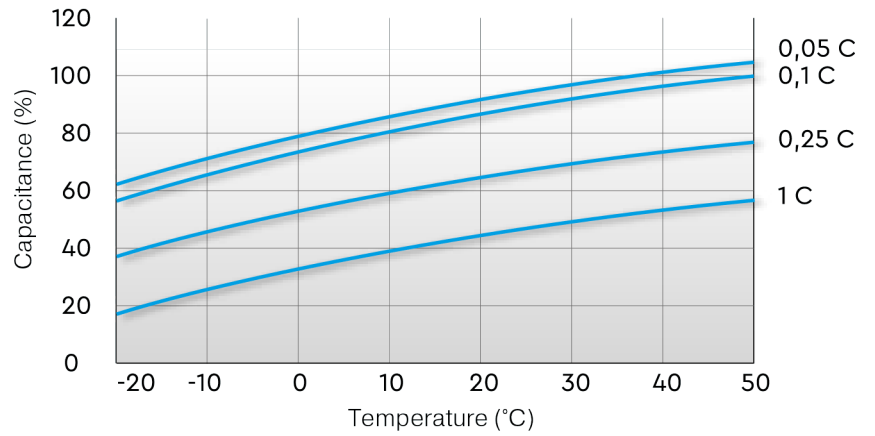

SERVICE LIFE IN CYCLIC MODE (Up to 55 Ah)

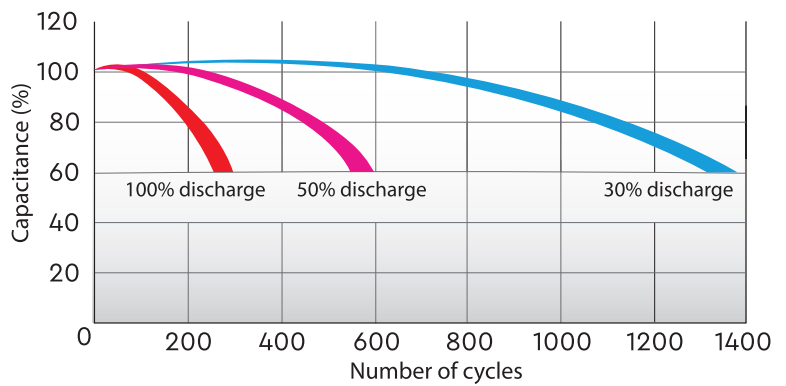

SERVICE LIFE IN CYCLIC MODE (Over 65 Ah)

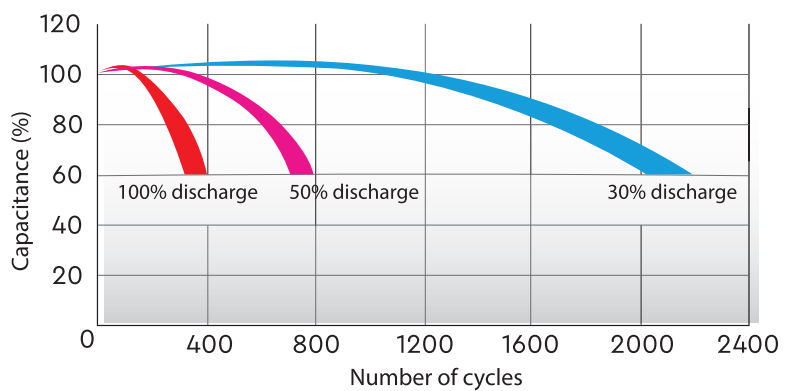

SERVICE LIFE IN BUFFER MODE

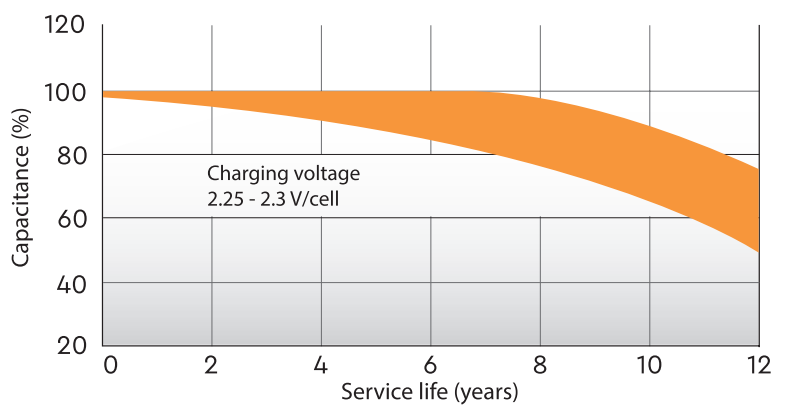

Standard sizes

Type	Voltage, V	Capacitance, Ah*	Length (±2), mm	Width (±2), mm	Height max (±2), mm	Weight, kg	Body	Terminal type
GEL 12-20 ND	12	20	181	77	167	5.3	E	Bolt + nut Ø 5.5 mm
GEL 12-33 ND	12	33	194	132	168	10.6	B	For M6 bolt
GEL 12-55 ND	12	55**	228	137	214	16.7	B	For M6 bolt
GEL 12-75 ND	12	75**	260	168	219	23	B	For M6 bolt
GEL 12-100 ND	12	100**	333	173	222	32.5	B	For M6 bolt
GEL 12-150 ND	12	150**	484	170	241	48.1	B	For M8 bolt
GEL 12-200 ND	12	200**	522	239	222	64.7	F	For M8 bolt

*Capacitance is indicated at the 20-hour discharge.

**Capacitance is indicated at the 10-hour discharge.

Discharge characteristics

Type	DC discharge up to 1.70 V/cell, A, at t 25°C.						Discharge with constant power up to 1.70 V/cell, W/cell, at t 25°C					
	10 min	15 min	30 min	1 hour	3 hours	5 hours	10 min	15 min	30 min	1 hour	3 hours	5 hours
GEL12-20 ND	41.4	33.2	19.9	11.4	4.75	3.17	77.7	63.3	38.1	22.6	9.41	6.31
GEL12-33 ND	67.8	54.1	30.2	20.6	8.13	5.62	118	97	58.0	37.5	15.6	10.9
GX12-55 ND	113	89.2	54.7	32.7	13.7	9.26	210	166	105	64.8	27.4	17.9
GEL12-75 ND	154	122	74.9	45.5	18.8	13.2	270	218	138	86.3	36.4	25.8
GEL12-100 ND	197	161	94.1	60.5	26.7	17.6	354	293	180	112	49.9	34.3
GEL12-150 ND	295	247	139	94.8	35.9	24.3	514	435	272	173	70.3	48.4
GEL12-200 ND	359	296	202	120	49.3	36.8	647	531	371	226	94.2	66.3

GX

SOLAR SERIES

DELTA GX series lead-acid monoblocks are manufactured using GEL technology.

A composite gel is used as an electrolyte, which ensures deep discharge resistance and high temperature stability of DELTA GX batteries. Designed for operation in both buffer and cyclic modes.

Scopes of application:

- Communication and telecommunication systems
- Uninterruptible power supplies
- Solar and wind power systems
- Autonomous power supply systems

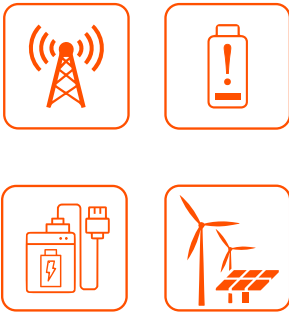

Service life	In buffer mode	15 years
	In cyclic mode	1400 cycles at 30% discharge depth
Self-discharge		Less than 3% per month
Charging method	DC voltage charging	25°C
	Cyclic mode	2,25-2,3 V/cell Temperature compensation - 5 mV/cell°C
	Buffer mode	2,35 - 2,4 V/cell Temperature compensation - 3.3 mV/cell°C

Terminal diagrams

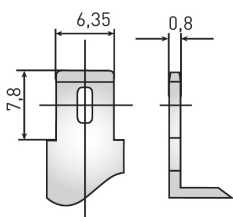

Knife F2

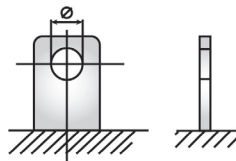

Bolt + nut

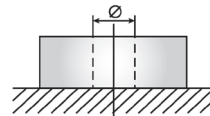

For bolt

Battery construction

Component	Positive plate	Negative plate	Container	Cover	Valve	Terminals	Separator	Electrolyte
Material	Lead dioxide	Lead	ABS	ABS	Rubber	Copper	Fiberglass	Sulfuric acid

Housing types

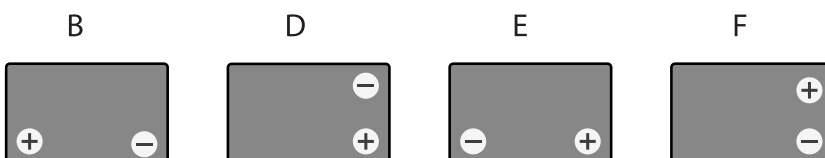



TEMPERATURE INFLUENCE ON THE CAPACITANCE

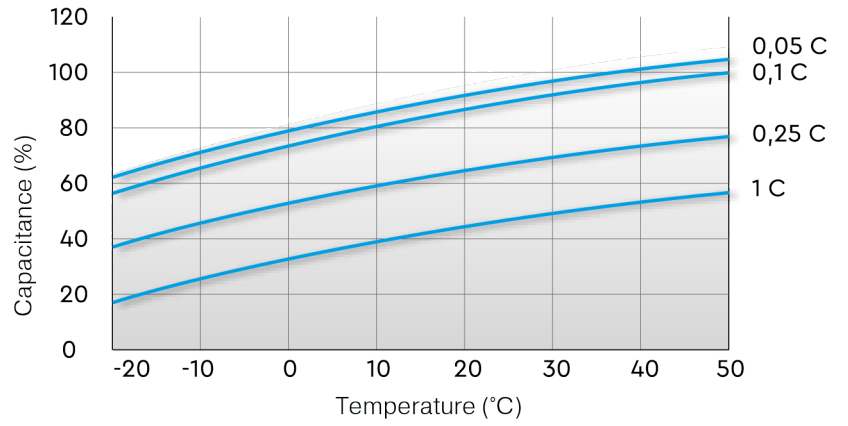

SERVICE LIFE IN CYCLIC MODE (Up to 60 Ah)

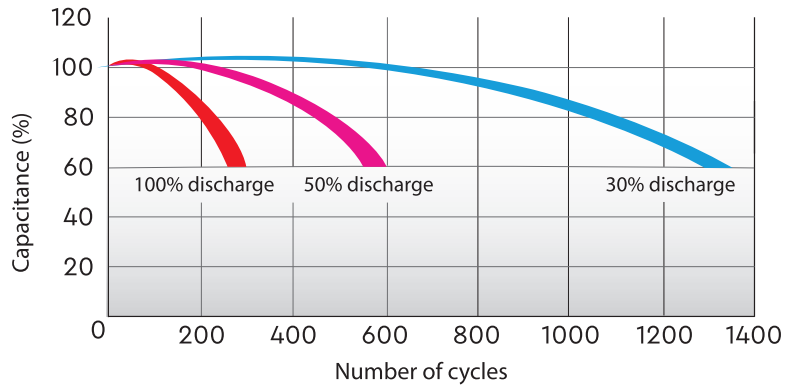

SERVICE LIFE IN CYCLIC MODE (Over 65 Ah)

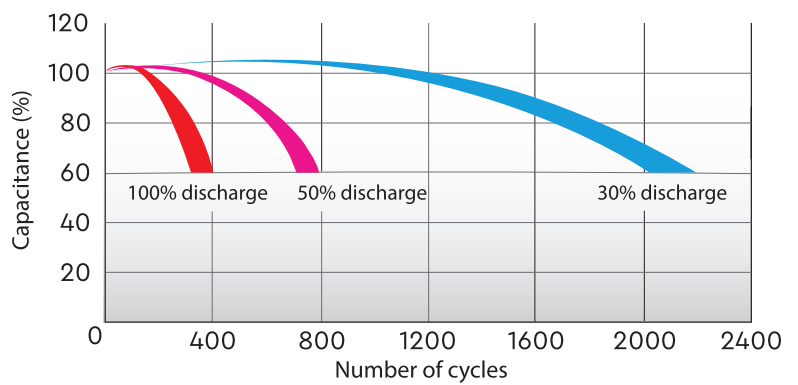

SERVICE LIFE IN BUFFER MODE

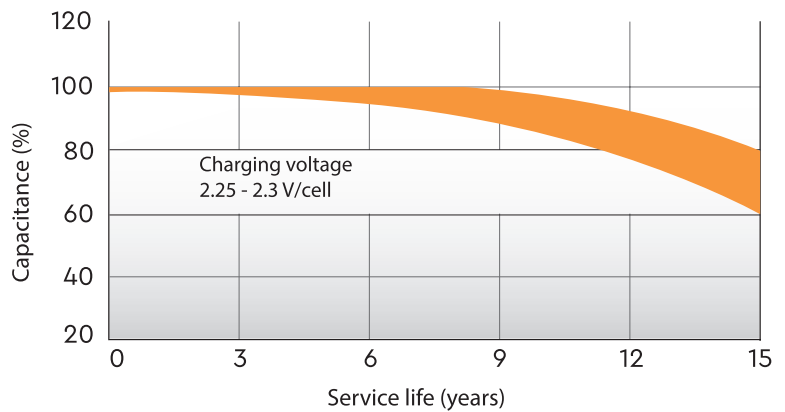

Standard sizes

Type	Voltage, V	Capacitance, Ah*	Length (±1), mm	Width (±1), mm	Height max (±1), mm	Weight, kg	Body	Terminal type
GX 12-12	12	12	151	95	101	3.67	D	Knife F2
GX 12-17	12	17	181	77	167	5.5	E	Bolt + nut Ø 5.5 mm
GX 12-24	12	24	166	175	125	8.3	E	For M5 bolt
GX 12-33	12	33	195	130	180	11	B	For M6 bolt
GX 12-45	12	45	197	165	170	14.6	E	For M6 bolt
GX 12-55	12	55	239	132	210	17.3	B	For M6 bolt
GX 12-65	12	65	350	167	183	23.4	B	For M6 bolt
GX 12-75	12	75	258	166	215	23.5	B	For M6 bolt
GX 12-90	12	90**	306	169	215	30	B	For M6 bolt
GX 12-100	12	100**	330	171	220	32	B	For M6 bolt
GX 12-120	12	120**	410	176	224	38	B	For M8 bolt
GX 12-150	12	150**	482	170	240	47	B	For M8 bolt
GX 12-200	12	200**	522	238	227	65	F	For M8 bolt
GX 12-230	12	230*	520	269	208	72.6	F	For M8 bolt

*Capacitance is indicated at the 20-hour discharge.

**Capacitance is indicated at the 10-hour discharge.

Discharge characteristics

Type	DC discharge up to 1.70 V/cell, A, at t 25°C.						Discharge with constant power up to 1.70 V/cell, W/cell, at t 25°C					
	10 min	15 min	30 min	1 hour	3 hour	5 hours	10 min	15 min	30 min	1 hour	3 hour	5 hours
GX 12-12	29.6	21.8	13.0	7.57	2.98	2.00	51.7	41.6	24.5	14.8	6.24	4.01
GX 12-17	42.9	32.6	19.3	11.6	4.49	3.00	75.8	58.5	35.0	21.5	8.92	6.04
GX 12-24	55.8	42.4	25.5	14.5	6.21	4.20	107	80.2	49.4	28.9	12.5	8.22
GX 12-33	69.2	55.2	30.7	20.9	8.30	5.72	127	102	57.9	39.5	15.9	11.1
GX 12-45	86.4	70.4	40.0	26.5	11.1	7.41	157	128	76.3	53.3	21.9	14.4
GX 12-55	115	90.6	55.6	33.3	13.9	9.40	213	169	107	65.8	27.9	18.2
GX 12-65	131	100	64.3	41.0	16.1	10.9	245	180	116	76.9	32.6	21.8
GX 12-75	156	124	76.4	46.4	19.1	13.4	281	238	141	91.7	37.0	26.5
GX 12-90	186	153	90	56.0	25.0	16.7	345	284	171	107	46.8	31.5
GX 12-100	200	164	96.0	61.5	27.2	18.0	360	299	183	114	50.9	35.0
GX 12-120	223	187	112	69.7	31.0	20.6	404	346	213	131	55.0	38.3
GX 12-150	300	252	141	96.7	36.4	24.7	523	443	277	186	71.4	49.3
GX 12-200	366	301	205	122	50.3	37.5	659	539	377	229	94.3	69.8
GX 12-230	404	383	240	150	67.8	44.9	736	666	462	291	129	86.1

CGD SOLAR SERIES

DELTA lead-acid batteries of the CGD series are manufactured according to AGM technology (electrolyte absorbed in a fiberglass separator).

As part of the active mass, a carbon addition in the form of graphene is used what makes Delta CGD batteries resistant to deep discharges and high temperature stability under adverse operating conditions. This series also features an increased number of charge/discharge cycles and duration of operation in heavy-duty systems based on renewable energy sources.

Scopes of application

- Uninterruptible power supplies;
- Communication and telecommunication systems
- Temperature stability of the battery;
- Solar and wind power systems;
- Autonomous power supply systems.

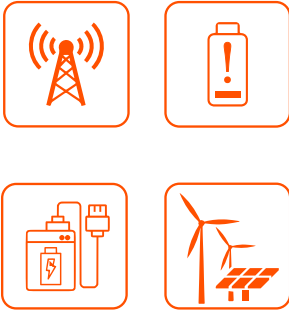

	In buffer mode	15 years
Service life	In cyclic mode	1800 cycles at 30% discharge depth. 2600 cycles at 30% discharge depth.
Self-discharge		Less than 3% per month
Charging method	DC voltage charging	25°C
	Cyclic mode	2,25-2,3 V/cell Temperature compensation - 30 mV/cell°C
	Buffer mode	2,25 - 2,4 V/cell Temperature compensation - 20 mV/cell°C

Terminal diagrams

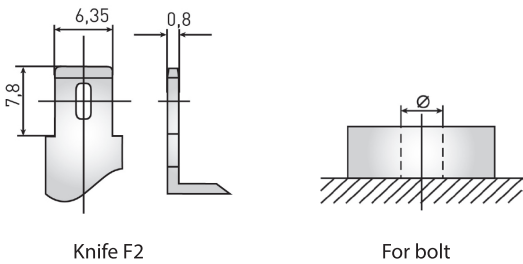

Battery construction

Component	Positive plate	Negative plate	Container	Cover	Valve	Terminals	Separator	Electrolyte
Material	Lead dioxide	Lead	ABS	ABS	Rubber	Copper	Fiberglass	Sulfuric acid

Housing types

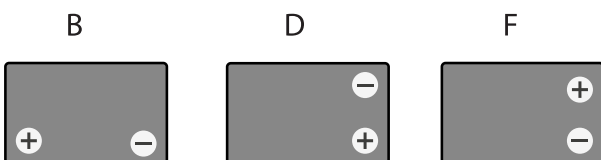



TEMPERATURE INFLUENCE ON THE CAPACITANCE

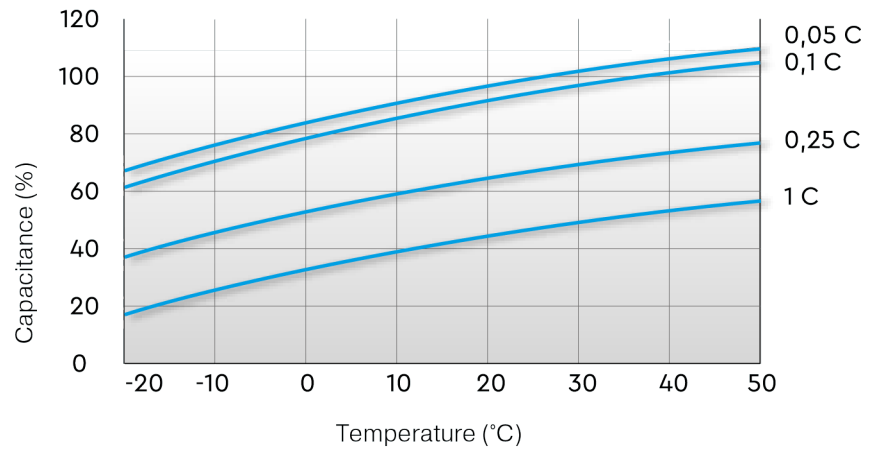

SERVICE LIFE IN CYCLIC MODE (Up to 55 Ah)

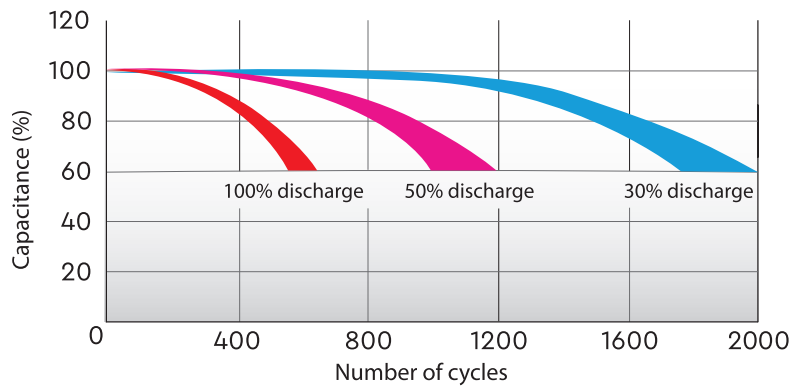

SERVICE LIFE IN CYCLIC MODE (Over 100 Ah)

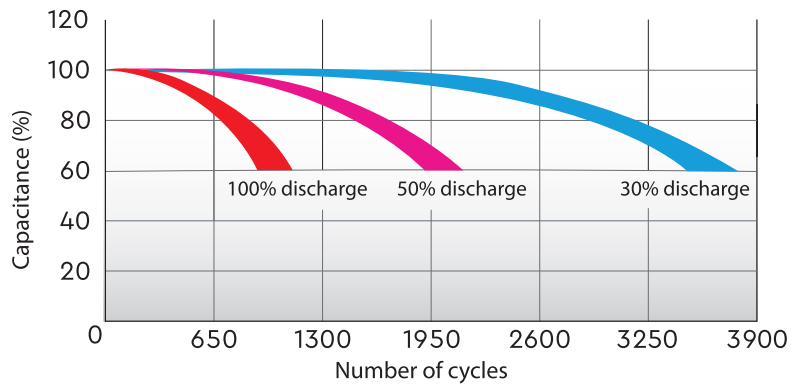

SERVICE LIFE IN BUFFER MODE

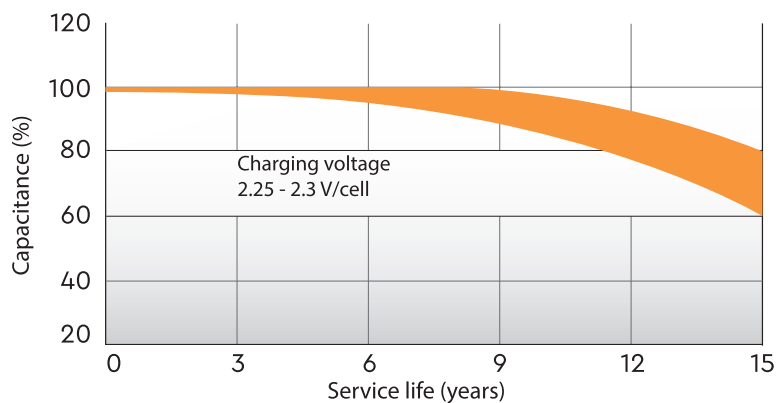

Standard sizes

Type	Voltage, V	Capacitance, Ah*	Length (±1), mm	Width (±1), mm	Height max (±1), mm	Weight, kg	Body	Terminal type
CGD 1212	12	12	151	98	95	3,9	D	Knife F2
CGD 1233	12	33	197	130	163	10,3	B	For M6 bolt
CGD 1255	12	55	230	138	205	18	B	For M6 bolt
CGD 12100	12	100	330	173	212	30	B	For M8 bolt
CGD 12200	12	200	522	238	223	62,5	F	For M8 bolt

*Capacitance is indicated at the 20-hour discharge.

**Capacitance is indicated at the 10-hour discharge.

Discharge characteristics

Type	DC discharge up to 1.70 V/cell, A, at t 25°C.						Discharge with constant power up to 1.70 V/cell, W/cell, at t 25°C					
	30 min	45 min	1 hour	3 hour	5 hour	8 hour	30 min	45 min	1 hour	3 hour	5 hour	8 hour
CGD 1212	11,7	9,35	8,18	3,00	2,22	1,46	26,9	19,8	16,3	6,33	4,13	2,62
CGD 1233	37,2	25,4	19,5	8,25	5,65	3,90	60,8	46,2	38,9	16,4	11,3	7,52
CGD 1255	55,8	41,5	34,4	14,7	9,80	6,65	106	78,2	64,3	30,2	19,5	13,1
CGD 12100	118	84,0	67,0	25,8	18,5	12,5	229	158	124	52,8	35,2	24,6
CGD 12200	203	147	119	55,7	36,6	24,4	380	277	225	104	70,9	48,8

FT-M

SPECIAL PURPOSE SERIES, FT-M TECHNOLOGY

DELTA maintenance-free front-end lead-acid batteries of series FT-M are manufactured according to AGM technology with an absorbed electrolyte. Thanks to this technology, the batteries do not need to be refilled with distillate throughout their lifetime.

Housing is optimized for installation in 19" and 23" telecommunication cabinets and racks. The front-end arrangement of the terminals ensures easy installation and maintenance during operation.

DELTA batteries of FT-M series are optimized for power supply systems of base stations of mobile operators and other telecommunication infrastructure facilities.

Scopes of application:

- Power supply of telecommunication equipment of mobile and fixed communication operators, Internet providers and backbone networks
- Use in «indoor» and «outdoor» cabinets, and communication containers
- Power redundancy for radio relay systems
- Operation in UPS and power plants
- Power racks for communication systems
- Telephone stations



Service life	In buffer mode	10-12 years
	In cyclic mode	1300 cycles at 30% discharge depth
Self-discharge		Less than 3% per month
Charging method	DC voltage charging	20°C
	Cyclic mode	2,35-2,4 V/cell Temperature compensation - 30 mV/cell°C
	Buffer mode	2,27 - 2,3 V/cell Temperature compensation - 20 mV/cell°C

Terminal diagrams

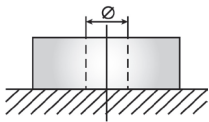

For bolt

Battery construction

Component	Positive plate	Negative plate	Container	Cover	Valve	Terminals	Separator	Electrolyte
Material	Lead dioxide	Lead	ABS	ABS	Rubber	Copper	Fiberglass	Sulfuric acid

Housing types

F

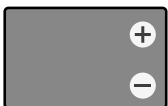

TEMPERATURE INFLUENCE ON THE CAPACITANCE

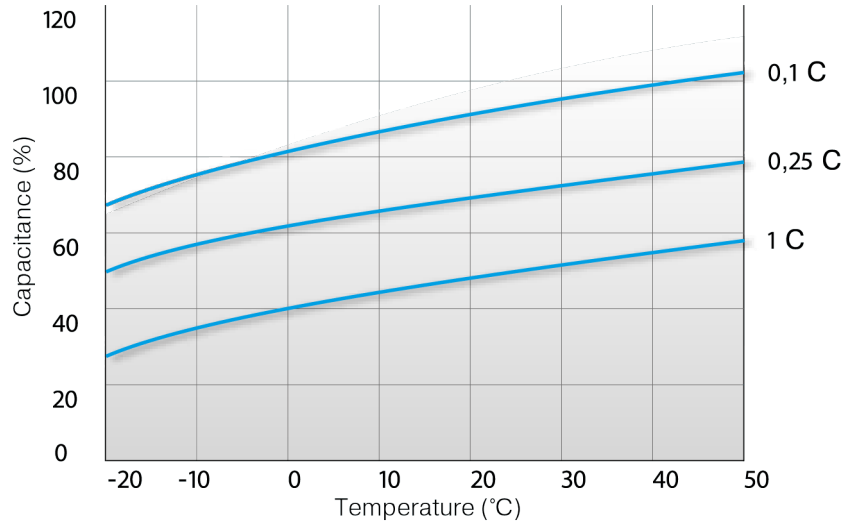

SERVICE LIFE IN CYCLIC MODE

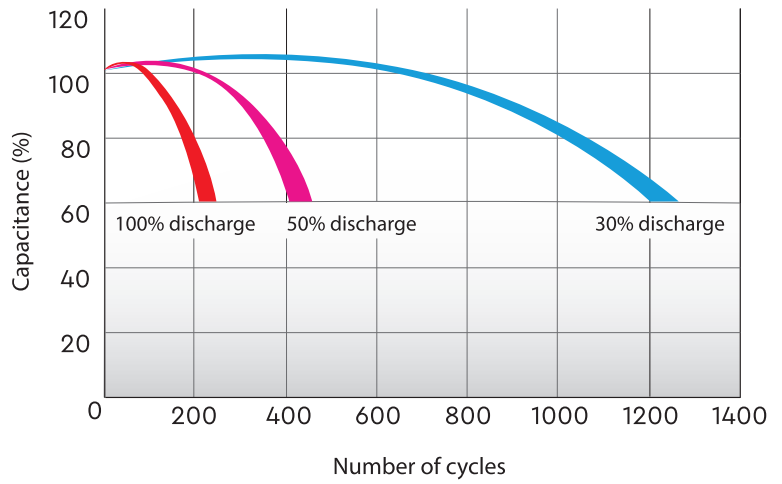

SERVICE LIFE IN BUFFER MODE

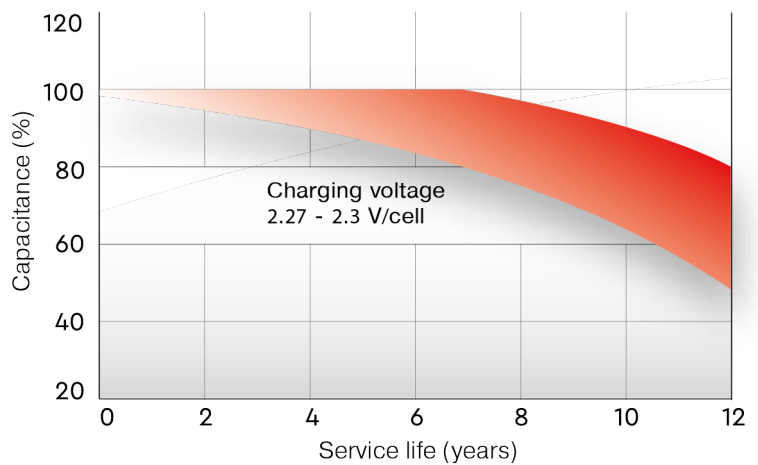

Standard sizes

Type	Voltage, V	Capacitance, Ah*	Length (±2), mm	Width (±2), mm	Height max (±2), mm	Weight, kg	Body	Terminal type
FT 12-50 M	12	50	277	106	243	16.3	F	For M6 bolt
FT 12-100 M	12	100	508	110	238	29	F	For M6 bolt
FT 12-105 M	12	105	395	110	293	31.5	F	For M8 bolt
FT 12-125 M	12	125	436	108	317	36	F	For M8 bolt
FT 12-150 M	12	150	548	105	316	45.5	F	For M8 bolt
FT 12-180 M	12	180	546	125	323	53	F	For M8 bolt

*Capacitance is indicated at the 10-hour discharge.

Discharge characteristics

Type	DC discharge up to 1.70 V/cell, A, at t 25°C.						Discharge with constant power up to 1.70 V/cell, W/cell, at t 25°C					
	30 min	45 min	1 hour	3 hour	5 hours	8 hours	30 min	45 min	1 hour	3 hour	5 hours	8 hours
FT 12-50 M	51.7	40.2	32.8	13.7	9.02	6.05	99.0	77.5	63.3	27.1	17.6	11.8
FT 12-100 M	95.1	68.8	55.6	25.5	17.5	11.9	178	133	106	50.2	33.8	23.5
FT 12-105 M	109	82.1	68.8	28.7	18.9	12.6	208	158	133	56.9	37.1	24.5
FT 12-125 M	127	96.0	80.1	33.6	22.9	15.3	232	178	146	62.8	42.3	28.7
FT 12-150 M	159	121	103	43.9	28.6	18.5	274	212	180	83.7	54.9	35.0
FT 12-180 M	181	133	109	48.0	32.1	21.6	326	249	211	93.2	61.2	41.4

CT STARTER BATTERIES

DELTA CT Series lead-acid batteries are specially designed for systems that use multiple powerful discharges.

They meet international safety standards and are recommended for use in motorcycles, scooters, water motorcycles, quad bikes, all-terrain vehicles, as well as gasoline and diesel generators. DELTA batteries of CT series offer an attractive price, excellent performance and high reliability.

Scopes of application:

- Motorcycles
- Scooters
- Quadrocycles
- All-terrain vehicles
- Hydrocycles
- Snowmobiles
- Motoblocks
- Diesel and gasoline generators



Self-discharge	Less than 3% per month
----------------	------------------------

Constant recharging voltage	14,4-14,8 V
-----------------------------	-------------

Terminal diagrams

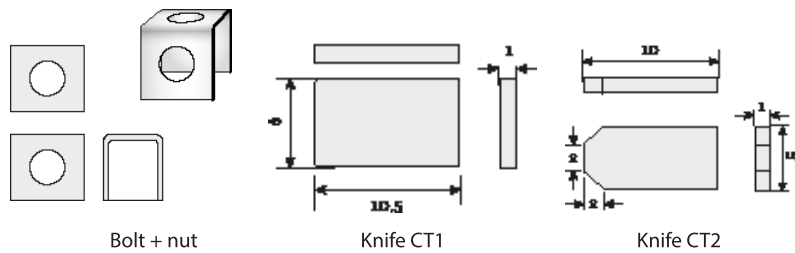

Housing types

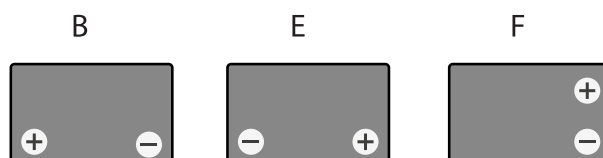

Standard sizes

Type	Voltage, V	Capacitance, Ah	Length, mm	Width, mm	Height max, mm	Weight, kg	Starting current, CCA (-18°C), A	Polarity	Body	Terminal type (*)
CT 12025	12	2.5	114	39	87	0.89	40	side (reverse)	F	Knife CT1
CT 12026	12	2.5	115	50	86	0.99	45	side (reverse)	F	Knife CT2
CT 1204	12	4	114	70	87	1.32	50	reverse (- +)	E	Bolt + nut Ø5 mm
CT 1205	12	5	114	70	106	1.82	80	reverse (- +)	E	Bolt + nut Ø5 mm
CT 1205.1	12	5	120	61	129	1.94	65	reverse (- +)	E	Bolt + nut Ø5 mm
CT 1207	12	7	150	86	94	2.47	105	direct (+ -)	B	Bolt + nut Ø6 mm
CT 1207.1	12	7	114	70	132	2.31	100	reverse (- +)	E	Bolt + nut Ø6 mm
CT 1207.2	12	7	114	70	108	2	130	reverse (- +)	E	Bolt + nut Ø6 mm
CT 1208	12	8	150	66	95	2.25	130	direct (+ -)	B	Bolt + nut Ø6 mm
CT 1209	12	9	150	86	108	3.03	135	direct (+ -)	B	Bolt + nut Ø6 mm
CT 1209.1	12	9	151	71	107	2.65	115	direct (+ -)	B	Bolt + nut Ø6 mm
CT 1210	12	10	137	77	135	2.79	100	direct (+ -)	B	Bolt + nut Ø5.5mm
CT 1210.1	12	10	150	86	93	2.95	190	direct (+ -)	B	Bolt + nut Ø6 mm
CT 1211	12	11	151	86	112	3.36	210	direct (+ -)	B	Bolt + nut Ø6 mm
CT 1212	12	12	150	86	131	3.85	180	direct (+ -)	B	Bolt + nut Ø6 mm
CT 1212.1	12	12	151	71	130	3.25	155	direct (+ -)	B	Bolt + nut Ø6 mm
CT 1212.2	12	14	151	71	146	3.9	155	direct (+ -)	B	Bolt + nut Ø6 mm
CT 1214	12	14	151	88	147	4.72	200	direct (+ -)	B	Bolt + nut Ø6 mm
CT 1214.1	12	14	132	89	164	4.6	165	direct (+ -)	B	Bolt + nut Ø6 mm
CT 1216	12	16	205	70	162	6.09	200	reverse (- +)	E	Bolt + nut Ø6 mm
CT 1216.1	12	16	151	88	164	5.25	230	direct (+ -)	B	Bolt + nut Ø6 mm
CT 1218	12	20	177	88	154	4.72	270	direct (+ -)	B	Bolt + nut Ø6 mm
CT 1220	12	20	204	91	159	6.5	250	reverse (- +)	E	Bolt + nut Ø6 mm
CT 1220.1	12	20	181	77	167	5.22	260	reverse (- +)	B	Bolt + nut Ø6 mm
CT 1220.1	12	20	177	88	154	6.3	270	reverse (- +)	E	Bolt + nut Ø6 mm
CT 1230	12	20	168	126	175	8.57	300	reverse (- +)	E	Bolt + nut Ø6 mm

Type	YUASA analog	Type	YUASA analog
CT 12025	YT4B-BS	CT 1211	YTZ12S, YTZ14S
CT 12026	YTR4A-BS	CT 1212	YTX14-BS, YTX12-BS
CT 1204	YB4L-B, YB4L-A, YTX4L-BS	CT 1212.1	YT12B-BS
CT 1205	YTX5L-BS, YTZ7S, YT5L-BS	CT 1212.2	YT14B-BS
CT 1205.1	12N5-3B, YB5L-B	CT 1214	YTX14-BS, YTX14H-BS, YTX16-BS, YB16B-A
CT 1207	YTX7A-BS	CT 1214.1	YB14-BS, YTX14AH, YTX14AH-BS
CT 1207.1	YTX7L-BS	CT 1216	YB16AL-A2
CT 1207.2	YTZ7S	CT 1216.1	YTX16-BS, YB16B-A
CT 1208	YT7B-BS, YT7B-4, YT9B-BS	CT 1218	YTX20-BS, YTX20H, YB16-B-CX, YB16-B, YB18-A
CT 1209	YTX9-BS, YTX9	CT 1220	Y50-N18L-A3, YTX24HL-BS, YTX24HL
CT 1209.1	YT9B-BS	CT 1220.1	YT19BL-BS
CT 1210	YB9A-A, YB9-B, 12N9-4B-1	CT 1220.1	YTX20L-BS, YTX20HL-BS, YB16L-B, YB18L-A
CT 1210.1	YTZ10S	CT 1230	YIX30L, YIX30L-BS, YB30L-B

Battery construction

Component	Positive plate	Negative plate	Container	Cover	Valve	Terminals	Separator	Electrolyte
Material	Lead dioxide	Lead	ABS	ABS	Rubber	Copper	Fiberglass	Sulfuric acid

EPS STARTER BATTERIES

The DELTA EPS (Extreme Power Series) starter accumulator batteries are sealed, maintenance-free lead-acid batteries manufactured with the use of the NANO-GEL technology especially for two-wheeled motor vehicles with high energy consumption. The EPS series is created to start engines in extreme temperature conditions as well as for the most powerful

SCOPE OF APPLICABILITY

- Motorcycles
- Quads
- Jet skis
- Snowmobiles

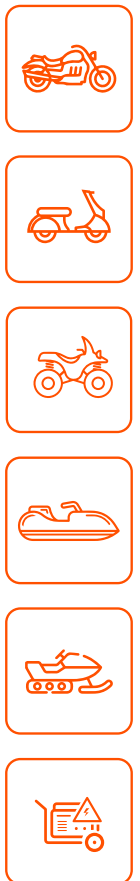

Self-discharge	Less than 3% per month
----------------	------------------------

Constant recharging voltage	14,4-14,8 V
-----------------------------	-------------

Terminal diagrams

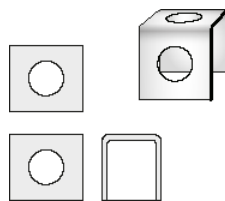

Bolt + nut



EPS

MODEL	JIS-CODE CONFORMITY	VOLTAGE, B	CAPACITY, AH	PEAK CURRENT, A	DIMENSIONS, MM (L*W*H)	POLARITY
EPS 1214	YTX14-BS, YTX14H-BS	12	12	210	149x87x144	(+ -)
EPS 1218	YTX20-BS, YTX20H-BS	12	20	270	176x87x154	(+ -)
EPS 1218.1	YTX20CH-BS	12	20	250	151x87x161	(+ -)
EPS 1220	YTX24HL-BS, YTX24HL	12	24	350	205x87x162	(- +)
EPS 12201	YTX20HL-BS, YTX20L-BS	12	20	310	176x87x154	(- +)
EPS 1230	YTX30HL-BS, YTX30L-B, YTX30L	12	30	400	166x130x175	(- +)

Battery construction

Component	Positive plate	Negative plate	Container	Cover	Valve	Terminals	Separator	Electrolyte
Material	Lead dioxide	Lead	ABS	ABS	Rubber	Copper	Fiberglass	NANO-GEL



DELTA
BATTERY

 **ENERGON**

delta-batt.com.tr